

# DUCATI

The Redline Magazine

1|2020

## Fabio Taglioni 100

The engineer, the man, the legend.



### THE WAY OUT

Escape with the Diavel

### DOMINIK E ANDREA

Life as a racer

### STREETFIGHTER V4

A healthy dose of madness

### SCOTT REDDING

Hail to the mad king

### DUCATISTI

Monster Squad

12

# ADVENTURE

India Dream Tour - European Grand Tour - Ducati E-bikes

53

# INNOVATION

Ducati Multistrada and Lamborghini Urus - 4Ever Multistrada - Eye Tracking

71

# EXPERIENCE

Worlds of DRE - DRE Rookie - Connect the DOCs

97

# FABIO TAGLIONI 100

The engineer, the man, the legend.

109

# SPEED

Carl Fogarty: Mr. Milestone - Brit Rock: Scott Redding - Ducati China Panigale Cup - Domme & Dovi

135

# STYLE

That Shade of Red - Massimo Vignelli - Diavel in NYC - Massimo Bottura - Streetfighter V4

147

# DUCATISTI

Monster Squad - Alessio Bertalot

151

*Land of Joy*

Maxime Richard - Custom Rumble - Icon Dark - Scrambler Concepts - 1100: Just PROs

# In the heart of the Himalayas



The incredible



Spiti Valley

Its name is Spiti, meaning "The Middle Land". Located in the North East region of the Indian state of Himachal Pradesh, this enchanting valley is surrounded by rugged mountains and dotted with small villages and monasteries. Incredible scenery for a Ducati Dream Tour that blends wonder, adventure and spirituality. Taking in the ancient culture, the starry skies and one of the most spectacular motorcycle itineraries in the world. This is the ride of a lifetime.

# INDIA Dream Tour



- Day 01  
Shimla  
31°6'16.5"N  
77°10'24.3"E
- Day 02  
Sangla  
31°25'38.2"N  
78°15'57.2"E
- Day 03  
Tabo  
32°05'42.1"N  
78°23'17.1"E
- Day 04  
Kaza  
32°13'39.8"N  
78°04'15.7"E
- Day 05  
Langza  
32°16'33.8"N  
78°05'01.2"E
- Day 06  
Nako  
31°52'40.8"N  
78°37'40.8"E
- Day 07  
Delhi  
28°38'32.8"N  
77°08'44.5"E



## Day 01

The adventure begins at the Ducati Store in Delhi. The ride to Shimla is approximately 350 km. We take it easy and, eight hours later, reach the hotel. We check-in and rest our bodies and minds. In the evening we gather around the bonfire, getting to know each other better.



## Day 02

An early start from Shimla as we make our way towards Kinnaur, famous for its caved roads. Once at Narkanda, we ride to the region's highest point, Hatu Peak, along narrow tracks that lead us up to the temple. Here we receive blessings for the next stage of our ride, along the NH22, which retraces the Old Hindustan Tibet Road (OHT). The road to Sangla offers panoramic views along River Satluj.

We reach our campsite late in the afternoon and gather at the river for some tea and pakodas, a typical dish of vegetables fried in chickpea flour. In the evening, we head out on foot to the nearby village of Batseri, known as the first "modern" village of the region. We then immerse ourselves in the lush greenery of the Baspa river and finish the evening around the bonfire.



## The height of experience

Riding along River Sutlej, the tarmac gives way to narrow broken roads before we take on one of the world's most nail-biting roads, 3500 metres up, with

no barriers or railings. We stop for lunch in Nako village, taking in the scenic view of the lake. We then ride on towards Tabo, our home for the night, where we come

across a 500-year-old mummy, perfectly preserved in a completely natural way.

# Day 03

### Beyond just riding



## Day 04

Early morning in Tabo sees us explore the amazing caves, where it is said that locals lived as recently as 30 years ago. Then begins what we might call the day of the monaste-

ries. We explore "Ajanta of the Himalayas", the Tabo Chos-Khor Monastery founded more than one thousand years ago. It's still early, so we can delight in the tranquillity of morning

prayers. We then venture out to explore some of the highest monasteries in Dhankar before heading to Kaza, Spiti's main town.



**PRO-1 PLUS**  
Electric Scooter

# Day 05

We ride up to the highest Post Office in the world, in Hikkim, after which we enjoy some maggi and butter-tea at a traditional baithak in a high altitude "café". On the way down, we stop in Langza, known for its fossils and huge golden Buddha statue, more than one thousand years old. Langza's population: 137!



# Day 06

Our destination for today is Nako village, the last village in Kinnaur right after we exit Spiti. We have lunch on the way, a very special one as it is cooked by all of us together. Once in Nako, we head for the viewpoint to enjoy the majestic sight of the entire valley. We also take a walk around the village before arriving at the campsite. We spend the evening relaxing at the lake, surrounded by the snow-capped mountains.

# Day 07

A night in Theog offers some spectacular views of the mountains. We travel via Chail down to the Chandigarh plains and on towards Delhi. We're back on level ground, back to the city. As well as the intense flavours of the wonderful Indian cuisine, our final lunch also leaves us with the sweet taste of unforgettable memories.

Ducati Motor Holding S.p.A. official licensed product.



8.5" Wheels with Inner Tube

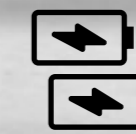

Battery 7.8Ah High Power



Up to 25km of Autonomy



Visit the Ducati website to see all the Ducati Dream Tours available worldwide.

# Europe: the perfect trip







# A MODERN Grand Tour

From 1700 up to the middle of the nineteenth century, discovering new places, languages, cultures and lifestyles was every young aristocrat's aim, as they headed off on the so-called Grand Tour. A trip lasting several months, even years, in discovery of Europe's greatest artistic and cultural treasures. And for me too, travelling means broadening my horizons. So a modern Grand Tour seemed to be the perfect solution, for a route that combines the pleasure of travel with the appeal of history and culture.



**Travelling with Andrea Rossi, enduro rider, Ducatista, explorer and dreamer.**



My starting point is Antibes, a jewel of the French Riviera and an inspirational muse for many artists. The crystal waters, colourful medieval buildings and scented Mediterranean scrub seem to want to keep me here, but the desire to get back on my Multistrada 1260 S Grand Tour is too great to resist. The waves break on the shore to my left as I take the road towards Cannes, leaving the riviera behind, bidding farewell to the dolce vita and heading towards the mountainous hinterland.



**Every city offers its own multi-coloured mosaic of scenery, smiles and flavours.**

**From one country to another with no obstacles or barriers. There's one word to describe this trip, and the word is freedom.**

From the Verdon Gorge, by way of Col d'Allos and Col de la Bonette, Europe's longest asphalt pass, as far as Basilea, the Alps flank my path like watchful guardians. In a play on contrasts, the austerity of the mountains further highlights the cordiality of the people who live in this area. Along the road and at the shops and markets, everyone makes me feel welcome, and so enjoying some of their local specialties seems like a great way to repay that hospitality. Then, satisfied in both body and mind, I'm back on the road, but not before filling the panniers of my Multistrada with some typical local treats.



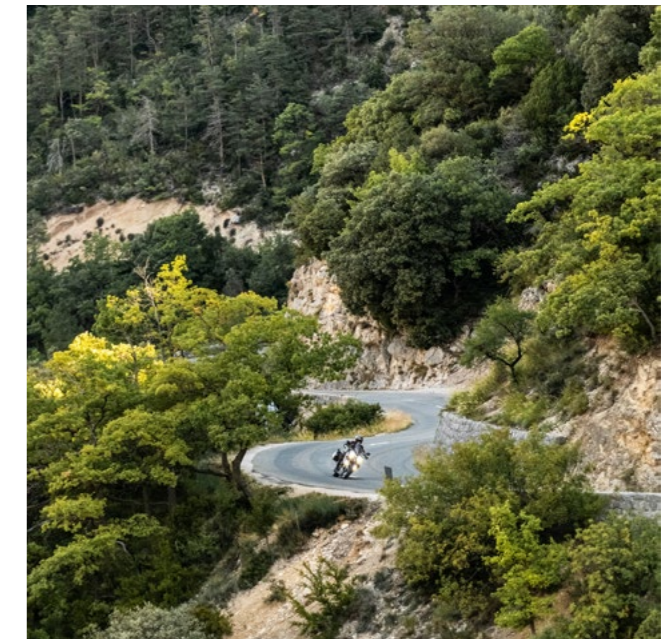

**Soaring mountains, placid rivers and lush forests add to the appeal of this enlightening ride.**



As I cross Switzerland and enter Germany, the scenery changes once again. I'm no longer surrounded by rugged mountains, but by a spectacular combination of lush nature and picturesque villages. And the Black Forest, with its immense woods and vibrant communities. The smooth slopes and pleasant turns of these roads allow me to enjoy both the view and the engine of my Multistrada 1260 S Grand Tour. The perfect travel companion, it adapts to any situation, powerful and safe on out-of-town roads, lightweight and quick in town, agile and audacious off-road.

After a break in prosperous Munich, I return to Italy across the Staller Saddle. My Grand Tour through the heart of Europe ends here, having taken in five countries and covered more than 1500 km. And I don't know if it was the myriad of colours, scents and smiles that I came across. Or the freedom of a journey without boundaries, the borders nothing more than markings on a map. But I get the feeling that this Old Continent is far ahead of its time. Just like my Multistrada 1260 S Grand Tour.



Learn more about the new Multistrada 1260 S Grand Tour.

# Unexplored paths

## Ebike Ducati

Ducati style is guaranteed on any path and in any environment, whether enduro, all-mountain or urban. Riding pleasure, handling and autonomy make for maximum safety and fun whatever the route.



An innovative design, natural performance. Created by Aldo Drudi, all Ducati Ebikes are developed in collaboration with Thok Ebikes and produced under licence by KP.

The Ducati Ebike range is extended with two new models and a special limited edition of the MIG-RR, the enduro e-mtb introduced last year. Just 50 have been built (and immediately sold!), complete with Öhlins suspension, electronic gearing and carbon wheels for sheer performance, no compromising. To this we add the MIG-S, an

All-Mountain with sports characteristics, perfect for those seeking an agile, high-performance bike that is fun in all conditions. And the E-Scrambler, a Trekking with top quality components inspired by the Scrambler world, ideal for cutting through city traffic freely and in style.

Powered by Thok Ebikes, an Italian company specialising in the production of pedal-assist bicycles.



Check out the details of all models.



# Innovation Pacemakers

Both Ducati and Lamborghini have innovation and performance in their DNA. Racing technologies have been pushed to the limit, but in recent years both brands have also applied their design and engineering experience to extreme projects, such as Multistrada and Urus. New operating conditions have triggered a whole new approach to vehicle dynamics and technologies, resulting in a period of "wild" innovation.

Travelling the roads of Sardinia aboard two gems of futuristic off-road technology. Ducati Multistrada and Lamborghini Urus are innovation pacemakers for the two firms.

## Ducati Electronic Suspension



With more than 400 possible parameter combinations, easily selected by the rider via the interface, Ducati electronic suspension allows for practical, intuitive and rapid setting adjustment, for the ideal suspension in any riding situation.

## Lamborghini Active Air Suspension



The Lamborghini Urus' adaptive air suspension system enables the vehicle to be raised or lowered according to road and driving conditions, or according to the driver's preference, by selecting the driving mode via the dedicated controller on the center console: the Tamburo.

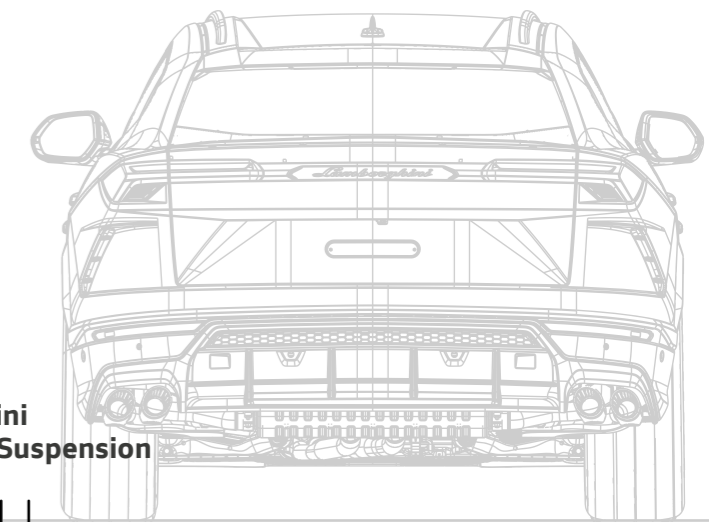
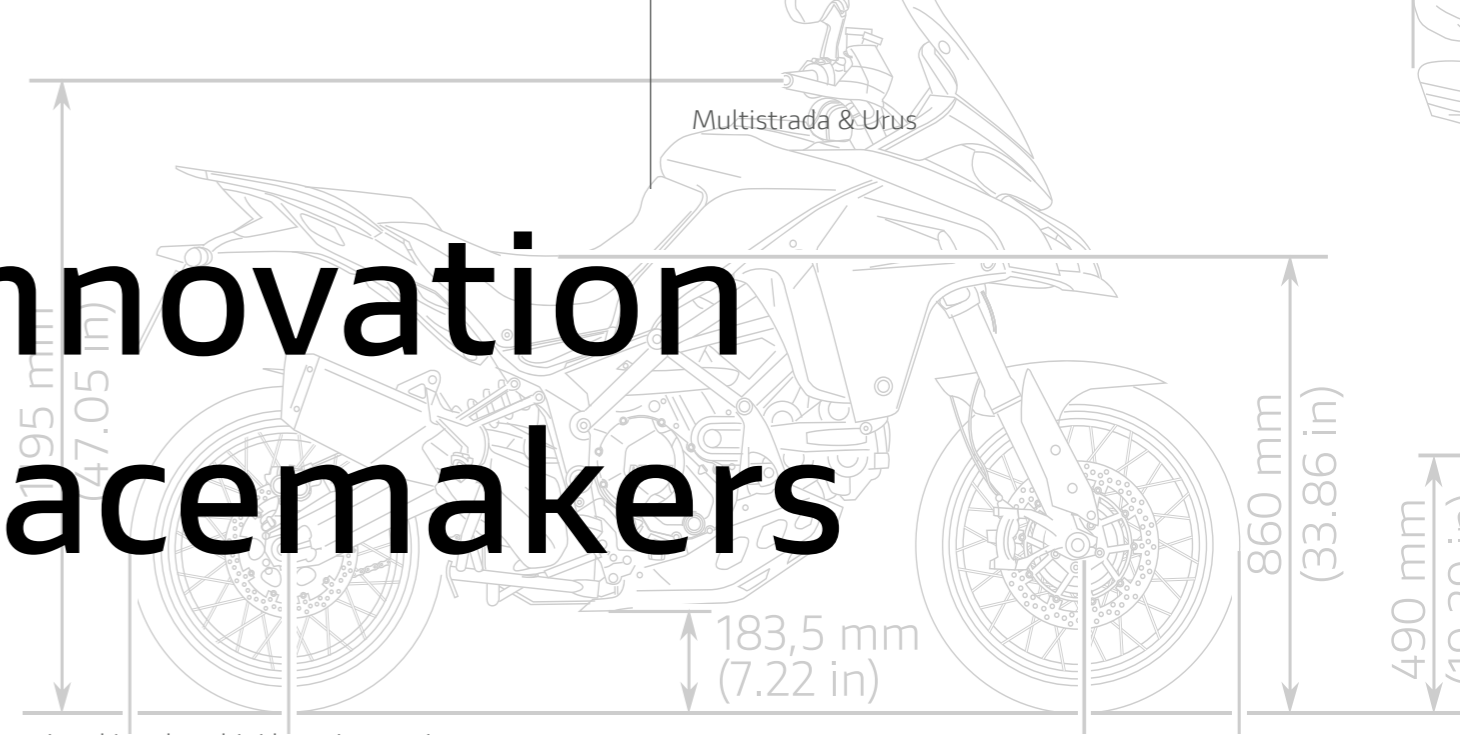

Continuously working on new concepts and testing technology to elevate off-road performance.



**Ducati Skyhook System**



The Skyhook system improves on traditional systems by offering continuous control of dynamic suspension behaviour, so that the rider feels as if they are suspended from a hook in the sky, ever stable and balanced.

**Lamborghini Active Anti-Roll Bar System**



The Lamborghini Active Anti-Roll Bar System allows absolute roll angle control up to complete suspension decoupling on the same axle, ensuring both excellent driving comfort on bumpy roads and higher lateral acceleration on bends.

# The finest technologies spring from the toughest of challenges.

**Ducati Riding Modes**



The current generation of Multistrada is equipped with the latest version of the system, introduced in 2010 with the famous "Four bikes in one" campaign. SPORT mode is for expert riders who want to test their limits. TOURING is perfect for long-range travel in maximum comfort. ENDURO ensures ideal off-road performance. URBAN offers agility and safety even on city streets or in the wet.



**Lamborghini Driving Modes**

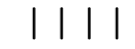

STRADA is the driving mode for ease of driving, comfort and safety; SPORT is for agility, responsiveness and fun to drive; CORSA is selected for precision and maximum performance. NEVE ensures ease and safety even on slippery surfaces; TERRA ensures comfort, ease and traction in off-road conditions; SABBIA is perfect for sandy surfaces. Finally, the EGO mode enables the driver to redefine the vehicle's dynamics according to preferences and needs in terms of traction, suspension, steering.



**At the very apex of the innovation chain, Multistrada and Urus push the boundaries of performance and pave the way for others.**



Check out the details of all models in the Multistrada family.

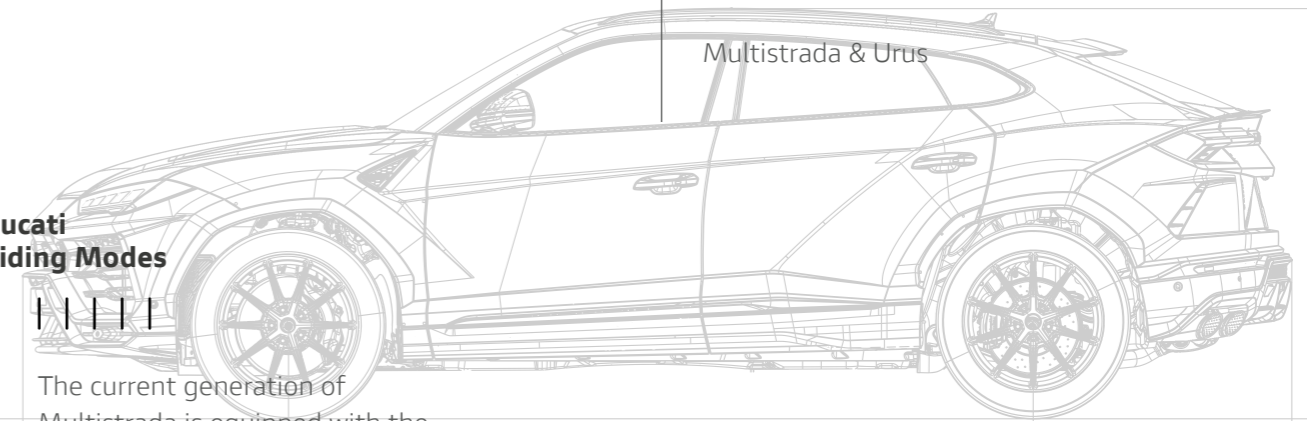

Multistrada & Urus

1638 (1623 - 1713) (\*)

# You choose the destination, we do the rest

**4Ever Multistrada is the latest milestone for a bike family that never ceases to amaze. We spoke to Marco Paradisi and Francesco Penazzo, respectively Field Quality Manager and Head of Service at Ducati.**

Sixteen years of continuous evolution in terms of the materials, technologies and development methods have ensured the Multistrada is an unstoppable travel companion, chosen by more than 100,000 Ducatisti around the world.

Today, with 4Ever Multistrada, the Multistrada broadens its horizons even further, offering those who ride it unlimited freedom and carefree riding.

A four-year warranty with unlimited mileage on all models: an important milestone that redefines reliability standards in the sector and rewards the professionalism of Ducati personnel, both in Borgo Panigale and around the world.

## **How has 4Ever Multistrada come about?**

We wanted to show everyone just how reliable our bikes have become and how important it is for us to meet the expectations of the Ducatisti. For years, we have refined processes, technologies and test methods, setting ourselves increasingly ambitious goals and investing huge resources into both the product and our service network.

## **What kind of rider owns a Multistrada?**

They have a strong passion for Ducati but are also very rational.



# You need only think about one thing – your next destination.

They cover more mileage than anyone else, in all conditions and across all countries, so they are the most demanding in terms of quality and reliability.

**And they expect the same outstanding service wherever they are.**

All our suppliers must respect very high standards and are constantly monitored. Then every market has specific needs of course, due to factors relating to culture, environment and usage. We carry out continual testing in all environments, all weathers, on all roads and at all altitudes. And we invest globally in order to train our dealers, from both a technical and human standpoint, to guarantee our customers the same service all over the world.

**What's the next big thing for the Multistrada?**

We can't reveal anything but, as is always the case with the "Multi", it will be something that pushes boundaries and redefines standards, and not only within its sector. Because this is in the very DNA of the bike, our pride and joy and a real reason to always give it our all.

For a full and updated list of countries in which 4Ever Multistrada is available, visit the dedicated page on the Ducati website.



## The comfort zone continues to expand. In every direction.



# LOCMAN<sup>®</sup>

ITALY

PASSIONE ITALIANA







# Developing 'super sight'

For Ducati, innovating does not just mean introducing technological solutions that can improve the riding experience. It also means taking the relationship between bike and rider to an increasingly high level. And this explains the DRE Academy, the official Ducati riding schools that have been training thousands of riders the world over since 2003. With a view to innovating motorsport teaching methods, Nicola Antonelli, Riding Experience Manager at Ducati, has started collaborating with Professor Giorgio Guidetti. His international experience, combined with Eye Tracking technology and the advice of professional Ducati riders has led to the development of new teaching programmes that, in true DRE style, combine fun with the building of skills.

## Professor Guidetti, why is it important to study eyesight?

When we move, there are two kinds of ocular movement, voluntary and involuntary. The latter, which makes up the vast majority, causes saccades, flashes of blindness lasting roughly 100 milliseconds. We experience roughly two per second, for a total of four hours of darkness per day. Not an entirely insignificant fact, and yet only professionals are aware of this. And illusionists, who take advantage of saccade blindness to ensure their tricks work.

Raising a rider's level of performance and safety is what really interests Ducati. And the best way to improve riders' skills and awareness level is with training, so that they can fully appreciate the benefits of two wheels and really enjoy the riding experience.

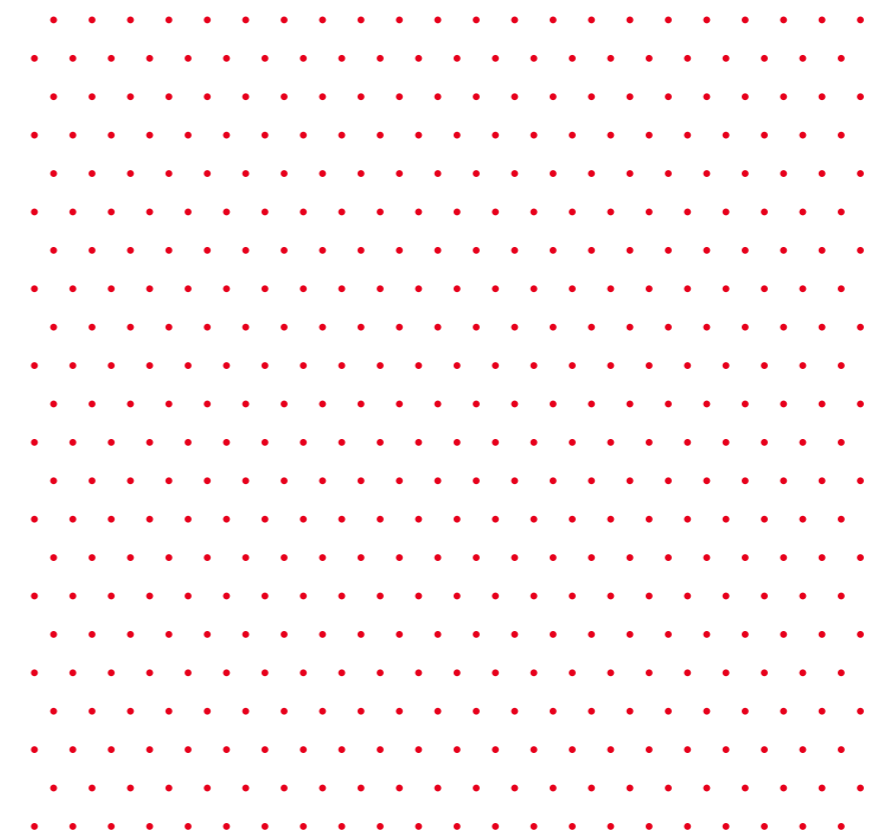

Professor Giorgio Guidetti is President of the Italian Vestibology Society and a passionate Ducatista.

# Learn to focus your gaze on what really counts.

**This meeting of science and passion has resulted in a training and research initiative to improve rider performance and safety.**



### Why is it important to do this in motorcycling?

Because optimising visual recon means increasing our perception of the environment, so our awareness, as well as our precision along a trajectory, so our performance. Our research has shown that, with professional riders, the perfect visual strategy is adopted almost automatically. On any given route, they will demonstrate significantly less saccade movement than amateur riders.



The initial scientific research involved more than 200 participants, including professional riders, amateurs and non-riders.

### Is it possible to train our eyes to improve our visual capacity?

One of the most important results of our research confirms that yes, if correctly taught and trained, even non-professional riders can increase their capacity and develop both their selective and general attention. Together with the Italian Road Police, we have carried out experimentation that has led to the definition of a training programme: just 10-15 minutes of exercises on the monitor, repeated for two weeks, can halve saccade movement and significantly increase performance on the road.

### How important is this collaboration with Ducati?

The first advantage has to do with the scientific aspect of course. Thanks to Ducati, we can involve motivated riders, both professionals and amateurs, who are happy to help us understand what we are studying. Then there is our pride in bringing an all-Italian team to the cutting edge of international research. For someone who has always been a fan of the brand, to do this with Ducati is truly priceless.



The use of Eye Tracking technology, already consolidated in the scientific research world but new to track, road and off-road riding courses, puts Ducati at the very cutting edge of motorsport-related training.

**Mastering technique and being aware on the bike: these are the two factors that make a difference when it comes to rider safety.**

# All the worlds of DRE

Road, enduro  
or track:  
all countries,  
all terrains.

Passion grows and expands, carves new paths and breaks boundaries. Created in 2003 as a way to perfect riding techniques with innovative and enjoyable programmes, the DRE courses are now available across five continents, heightening the performance and safety of motorcyclists all around the world. Whether on track, road or off-road, in the USA, Europe or the Far East, participating in a DRE course is an unforgettable experience, thanks to the team of professional instructors, exclusive locations and the possibility to test the very latest Ducati models. But what really makes the DRE so unique is the fun, adrenaline and satisfaction you experience as you become one with your bike, feeling part of the big Ducati family and meeting new people with whom to share your passion.

**Passion rides the world with the Ducati Riding Experiences: endless roads on which to live the dream.**



# DRE Enduro-ing in Europe and the US

For some people, the world is nothing more than an endless path to be travelled on one's bike. And it is for this kind of rider, who revels in the pleasure of discovery and loves to adventure where others have not, that the DRE Enduro exists. Coordinated by Beppe

Gualini, DRE Enduro is the experience designed to impart adventuring techniques and off-road riding secrets. All while taking in dream itineraries, in some of the world's most suggestive spots, and exploiting all the technology and versatility of the Multistrada.

Whatever the conditions and coordinates, all that matters is setting off in search of discovery.



Practicing and mastering off-road riding techniques under the watchful eyes of the DRE instructors and all while immersed in nature.



# Far off the beaten track.

Equipped with Scorpion Rally tyres, the Multistrada Enduro 1260 is the undisputed star of the DRE Enduro.

Horizons that continue to expand, from the snow-capped peaks of the Rocky Mountains, to the mirror-like waters of the Dutch polders, by way of the legendary Spa-Francorchamps woods, DRE Enduro roads lead to new wonders of the world. On asphalt or sand, earth or

gravel, DRE Enduro is synonymous with adventure, discovery and freedom. To be experienced aboard the Multistrada family of bikes, and accompanied by a team of professionals, headed up by the master of adventure himself, Beppe Gualini.



Learn more about the Multistrada 1260 Enduro.

By working in harmony with the bike, DRE Enduro participants learn to fully enjoy the infinite potential of the Multistrada. This all-in-one bike is unbeatable in terms of performance, comfort and versatility, even over long distances, the perfect travel companion then, able to transform any road into land to be conquered.

**Enjoy the ride, and you will enjoy the bike. Improve as a rider, and the bike will improve your riding.**

Overcoming obstacles, braking on rough ground, taking on the uneven surfaces typical of the desert: honing your off-road riding techniques means increasing your control and enjoyment on off-road adventures while also facilitating your road riding.

# DRE Enduro is where adventure begins. And never ends.



**When riding off-road, weight distribution is crucial. With DRE Enduro, riders learn to achieve and maintain the perfect balance.**



View all 2020 DRE Enduro Academy dates and book your course.

**DRE Enduro is for both beginners who seek greater confidence and skilled adventurers who want to do more.**



You don't have to have crossed five continents to take part in the DRE Enduro. The teaching content is in fact designed for riders of all levels, from the beginner who seeks confidence and control in situations of low grip to those who want to learn techniques from more expert riders. Divided into small groups based on experience, all par-

ticipants are watched over by the team of DRE instructors who make use of practical exercises and off-road itineraries to impart riding secrets such as the correct riding position and the use of traction, in an experience that combines two-wheeled fun with the appeal of nature.

# Road Academy: take control!

**DRE Road is the experience designed to help riders improve their technique and find perfect harmony with their bike.**

Aimed at both novice riders and the more expert, DRE Road is the course that helps improve both technique and awareness aboard a new Ducati at a real racetrack. Guided by the DRE instructors, participants practice in the paddock area, working on their skill and control before seeing the improvements made during a long and enjoyable track test session. DRE Road is also the only DRE course that allows riders to test new models in the Diavel, XDiavel, Multistrada, Monster, Hypermotard, Supersport, Scrambler and Streetfighter families, all equipped with the latest technology.



View all 2020 DRE Road Academy dates and book your course.



# DRE Racetrack at the Ningbo circuit

**Enthusiasm and passion go full throttle as DRE Racetrack hits the Ningbo International Circuit in China.**

Winds of adrenaline are blowing in the East. Aspiring racers and Ducati China Panigale Cup participants come together with Dario Marchetti and the team of DRE Racetrack instructors at the Ningbo International Circuit. Their goal? To grasp the techniques and secrets of track riding. In recent years, the Chinese passion for speed has grown at an incredible rate. As has the popularity of Ducati, with an increasing number of people choosing the DRE Racetrack courses as a way to familiarise themselves with track riding and get the best out of the unmistakable red bikes.



**The DRE Racetrack team joins one of the strongest Ducati communities in the world.**



**With DRE Racetrack, first you listen to the pros and learn their tricks...**



**...and then you test yourself on track!**



**Between the kerbs of a real international circuit, just like the pros.**

With a theoretical briefing and a practical session with Ducati superbikes, DRE Racetrack participants hone their racing spirit and strive for maximum performance, learning to increase their corner speed, fully exploit acceleration and make their riding smoother.



**DRE Racetrack is the DRE experience for those seeking the excitement of the track.**



View all 2020 DRE Racetrack Academy dates and book your course.

# A SPECIAL VERSION OF A SPECIAL BIKE



## 1/12 Motorcycle Series Ducati 1199 Panigale S Tricolore (Item 14132)

- ★READY TO ASSEMBLE 1/12 SCALE PRECISION STATIC MODEL KIT
- ★ACCURATELY RECREATES TRICOLORE MODEL WITH RED, WHITE AND GREEN MARKING SCHEME ON ITS ELEGANT COWLS
- ★SCREW-ATTACHED SIDE COWLS CAN BE REMOVED AFTER ASSEMBLY
- ★MONOCOQUE FRAME AND L-TWIN ENGINE ACCURATELY DEPICTED
- ★REAR DAMPER USES METAL COIL SPRING
- ★RACING STAND INCLUDED
- ★HIGH-QUALITY CARTOGRAF DECALS INCLUDED ★LENGTH: 173mm

●CEMENT & PAINTS ARE SOLD SEPARATELY. ●IMAGE SHOWS ASSEMBLED AND PAINTED KIT.



TAMIYA, INC. 3-7 ONDAWARA, SURUGA-KU, SHIZUOKA 422-8610 JAPAN





**Safety and enjoyment.**

# DRE ROOKIE ACADEMY

**In an absolute first for the motorcycle world, Ducati is sharing its knowledge on safety to educate young riders about best riding practices.**



DRE Rookie is the new DRE Academy course dedicated to young riders and the owners of restricted bikes.

Developed around a teaching programme that introduces technological elements, the DRE Rookie teaches participants the tricks used by real riders, helping them to unleash their potential in a safe and enjoyable way.

DRE Rookie is born out of the Safety Project and highlights the Ducati commitment to promoting the concept of responsibility and safe riding among young people.

In 2020, the course is officially added to the DRE calendar, the team of professional DRE Academy instructors having fine-tuned and tested the format with the help of a very special rider, Andrea Pirillo.

**Combining theory and practice, training and fun, the unique and distinctive Ducati Riding Academy format is now also available to youngsters.**



Some first impressions of the DRE Rookie with Andrea Pirillo, YouTuber and Ducati Brand Ambassador.

Why is a course like the DRE Rookie so important for young riders?

With the DRE, you really have chance to understand the workings of the bike, from when you switch the engine on to when you get off the bike. You learn to use the clutch, to adopt the correct riding position, particularly through the turns, and to make the most of the advanced electronics systems that Ducati bikes offer. And then you also learn to become more aware, practicing what to do in dangerous situations that may arise on the road in everyday life.

Your fans (also) love you for your acrobatics. How would you explain to them that safety always comes first?

You learn many things as you grow up... When I was younger, I didn't pay attention to protectors, I thought they were just added 'weight' on the bike. I soon released that they're vital, and now I'd never ride without a back protector, elbow guards, gloves and trousers. Safety is also about adapting your riding to the place and situation though. You must pay a lot more attention on the road than you do in a controlled environment like the circuit.

What advice would you give anyone riding a bike for the first time?

Two wheels will always make for unique emotions, so my first piece of advice is to take that first step into this world. If you are hesitant because you think it's a bit dangerous, sign up for a DRE course and you'll see that everyone can have fun and learn to ride in total safety!



View all 2020 DRE Rookie Academy dates and book your course.

# PLUG & RIDE

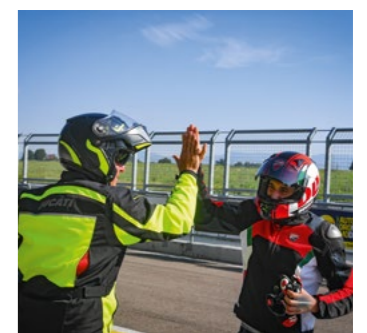

● Now Live

Monster 797, Monster 821, Hypermotard and Supersport. Ready for your first DRE?



# START

# YOUR

# EVOLU-

# TION



# Red Hot Family

More than 250 DOCs, spread across every continent, ensure that the passion never fades in the world of Ducati. Places to meet and share that Ducatista pride, the Desmo Owners Clubs are all about exclusive experiences, new friendships and great fun, and the red bikes themselves of course. On these pages, we've asked five DOC presidents - Zac, Lisa, Ange, Hermina and Mattia - to talk to us on behalf of the 30,000+ DOC members around the world. They tell us how their clubs harness this passion and explain why they think the Ducati community is the very best of all.



# Connect the DOCs

# What's better than having a passion? Sharing it!

## What's the best thing about being part of a DOC?

**Zac\_** The link between the amazing feeling and support of the Ducatisti "family", and the fun of riding such beautiful and artfully designed motorcycles.

**Ange\_** For me, DOC is all about the members and our shared enthusiasm! As individuals we come together because of what we ride, then we mesh and make connections with those that share the same loyalty to Ducati. Our family!

**Hermina\_** Getting to know the same type of crazy as you are for the first time in your life? I think that was the first thought that entered my mind when I joined our first Ducati Klub Slovenija event. It was a Ducati wedding and I will never forget it!



**Ange Richardson, New Zealand DOC**



**Hermina Steržaj, Ducati Klub Slovenija**

**Ange\_** Our team of brilliant, motivated and talented committee members, tour directors and event organisers, who are a reference for all Ducatisti in New Zealand and a great example of team spirit, integrity and passion.



## What makes your DOC special?

**Lisa\_** Though our DOC was only founded one year ago, we have a wide variety of members. There is true respect for every rider and every Ducati motorcycle.

**Zac\_** The generosity and support of our members. And the incredible North Californian scenery, such a gorgeous backdrop whether we're on a relaxing nature tour or a spirited canyon ride.

**Mattia\_** Every DOC is special, each with its own unique characteristics. The friendly atmosphere, the wanderlust and our passion are what brings us together.

**Mattia Gozzo, DOC Rovigo**



**How does Ducati make you feel part of the family?**

**Lisa\_**DOCs are always being promoted and encouraged to create communities around the world. We love these incredible bikes and naturally want to meet and talk to others who share the same passion.

**Ange\_**As president of DOCNZ, I appreciate the support from the DOC office, always ready to share ideas, stories, opportunities. Basically, always ready to embrace us as part of the FAMILY!

**Hermina\_**The World Presidents Meeting is the greatest meeting of all, attended by all the craziest Ducatisti. And then there's World Ducati Week, which is basically like Mecca for us!

**Zac Bacon, Sacramento DOC**



**Lisa Bennett, North Texas DOC**

**One last thing: why Ducati?**

**Hermina\_**Because the first bike I sat on was the Monster and I knew it would be mine. Then the first sports bike I noticed was the 999 and the first I fell in love with was the 1098. Ducati changed my world.

**Zac\_**Have you seen or heard the bikes?! That's why! Seriously, just stand close to the exhaust of a Ducati and you feel it. It touches something inside, and once you've felt it, you can't say no.

**Lisa\_**Because they're not only fantastic bikes. There is an entire community of riders and enthusiasts around the world who bring so much meaning to this incredible brand.

**Ange\_**Because Ducati encompasses a heritage of fine craftsmanship, sophistication, and first-rate performance, as well as great style.

**Mattia\_**Because Ducati is number 1. I've never had any other bike and I don't want any other bike. Ducati touches your heart. When you buy a Ducati, you don't just buy a bike but an entire world!



View the DOC events calendar and find your nearest Club.



**UPRISER**

**YOU'VE NEVER SEEN  
AN RC MOTORCYCLE  
LIKE THIS BEFORE.**

*Designed in partnership with* world-renowned motorcycle maker **Ducati**, Upriser Ducati Panigale V4 S RC is the first ever RC motorcycle to feature Omni-wheel technology, allowing it to perform amazing stunts on demand.



**OWN  
THE  
STORY**

**MULTI-DIRECTION  
WHEELIES**



**PATENTED OMNI-WHEEL  
TECHNOLOGY**



**LED HEADLIGHTS &  
REAL SUSPENSION**



Learn more about this new technology at [WWW.UPRISERRC.COM](http://WWW.UPRISERRC.COM)



Ducati Motor Holding S.p.A official licensed product.

# Fabio Taglioni: a modern genius

2020 marks one hundred years since the birth of Fabio Taglioni, the designer responsible for leaving a first, definitive mark on the history and technological evolution of Ducati. An engineer, but first and foremost a man, whose ideas continue to inspire the work of technicians in Borgo Panigale and across the entire motorcycling sector, which owes so much to his extraordinary intuition. Leaving an invaluable legacy in both quantity and quality, Fabio Taglioni seems more legendary figure than real person.





# 1954 — The “volcanic” 1962 Fabio Taglioni.

In 1953, Italy was on the brink of the economic boom. The ‘Made in Italy’ was beginning to attract attention and interest around the world. Ducati, state-owned for five years at that point, decided that it was time to revolutionise its future. The company was thus split into two branches: Ducati Elettrotecnica, the direct descendent of the firm founded by the three Ducati brothers in 1926, and Ducati Meccanica, which would focus solely on the production of motor vehicles and related products.

The newly appointed director of Ducati Meccanica, Giuseppe Montano, started out with very clear ideas, immediately wanting a product that would be a winner both on and off the track. It was he who contacted Fabio Taglioni, a promising engineer at the time who was on the up following successful stints at Ceccato and Mondial.



Taglioni was an old-school engineer. His technical references included British bikes, reliability champions, and Moto Guzzi, the star of the racing world. As brilliant as he was ambitious, the young designer seized this new opportunity, agreeing to Montano’s request to work salary-free for the first six months.

His first Ducati was the Gran Sport 100 Marianna, a race bike built with one precise goal: to win the long-distance races so fashionable at that time, like the Milano-Taranto and the Motogiro d’Italia, and thereby introduce Ducati to the masses.

The dazzling success of the Marianna and the 125 Desmo resulted in great visibility for the Ducati brand.



Tartarini and Monetti’s achievement laid the foundations for the development of Ducati’s global commercial network.

The Marianna 100 got off to a dazzling start, dominating the 1955 Motogiro with Modenese rider Gianni Degli Antoni as well as the Milano-Taranto that very same year, with Alberto Gandossi in the 100 class and with Giuliano Maoggi in the 125 class, the latter also the overall winner. The Marianna paved the way for an incredible series of winning projects and products, not least the Grand Prix 125 bikes, first the double shaft and then the “triple shaft” Desmo, the first Ducati equipped with the desmodromic valve control system.

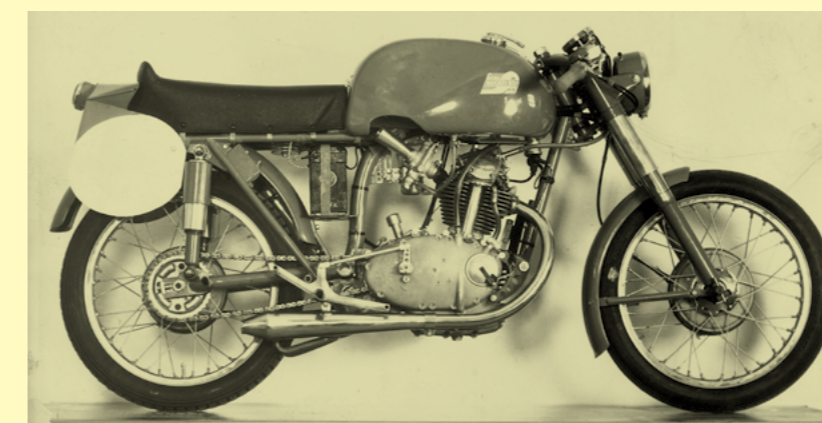

Ridden by Gianni Degli Antoni, the 125 Desmo won the 1956 Swedish GP at its first attempt, proving stronger than all its rivals.

In 1957 Taglioni developed some very successful road models inspired by the Marianna, namely the 100



The Gran Sport 100 Marianna, the first Ducati created by Fabio Taglioni.

reliable the Bolognese bikes were and guaranteeing the company new commercial opportunities in the process.

Then came the success of models such as the 175 America, in 1958, and the first 250 scramblers, created in 1962 following a request by American importer Joe Berliner.

**On-track success has global reach.**

and 125 cc Sport series and the Ducati 175, the first bike to ride around the world. The men who achieved this impressive feat were Leopoldo Tartarini, an official rider on the Ducati team, and his childhood friend Giorgio Monetti, the pair showing the world just how

# 1963 — From mono- 1969 to twin-cylinder.

**T**hen came the '60s and '70s. Amidst the various revolutions, large and small, being seen across Italy and the world, Taglioni's genius continued to expand the Ducati brand, particularly overseas. The growing relationship between the Bolognese manufacturer and Joe Berliner led to the creation of the Apollo, a maxi-bike designed by Taglioni and inspired by classic American cruisers.

The Apollo would remain a prototype, but this unique example would nevertheless go down in history as the first four-cylinder Ducati to be equipped with an "L" line engine, and from which Taglioni would take his cue a few years later when creating the 500 GP (race) and the 750 GT (road).

Before turning to twin-cyl-



The Apollo engine would inspire the "L" twin, a future hallmark of Ducati bikes.

inders, Taglioni updated the medium/large mono-cylinders. 1965 saw the presentation of the 350 Sebring, built around the base of the powerful 250 Mach 1 and 250 Diana, while 1967 brought a new family of single cylinders, known as "wide case", the first to boast the desmodromic timing system, which had until then only been seen on race bikes. The 250 and 350 cc Mark 3 D, where the letter "D" indicates the Desmo engine type, bear the unmistakable hallmarks of the genius. All they needed was a fairing and a race exhaust and they were transformed into race bikes. In this way,



On the back of its success in the US, the Scrambler was set to become a symbol for an entire generation of Italians too.

albeit in an "unofficial" capacity, Ducati once again took centre stage in championships with a product accessible to many young riders, competing in the Italian championship as well as the races of the Moto-



With the Mark 3 D bikes, complete with desmodromic system, many riders would make a first foray into the world of racing.

temporada Romagnola, the legendary series run on the city circuits of Modena, Cesenatico, Rimini and Riccione.

These were the roaring years. New trends, lifestyles and desires were stemming from the USA and the UK.

It was the age of jeans, protests, the Beatles and the Rolling Stones. To attract the youngsters, Ducati brought the Scrambler to the Italian market, updating the 1962 version with "wide case" 250, 350 and 450 cc engines.

The move proved very successful, the Scrambler becoming one of the most iconic bikes ever built by Ducati, a symbol for all those fans who dreamed of living like "Easy Rider" and for an entire generation seeking greater freedom, light heartedness and self-expression.

**The ideas  
keep coming,  
the brand  
expands.**

# 1970 — The twins, 1976 — from racing to the road.

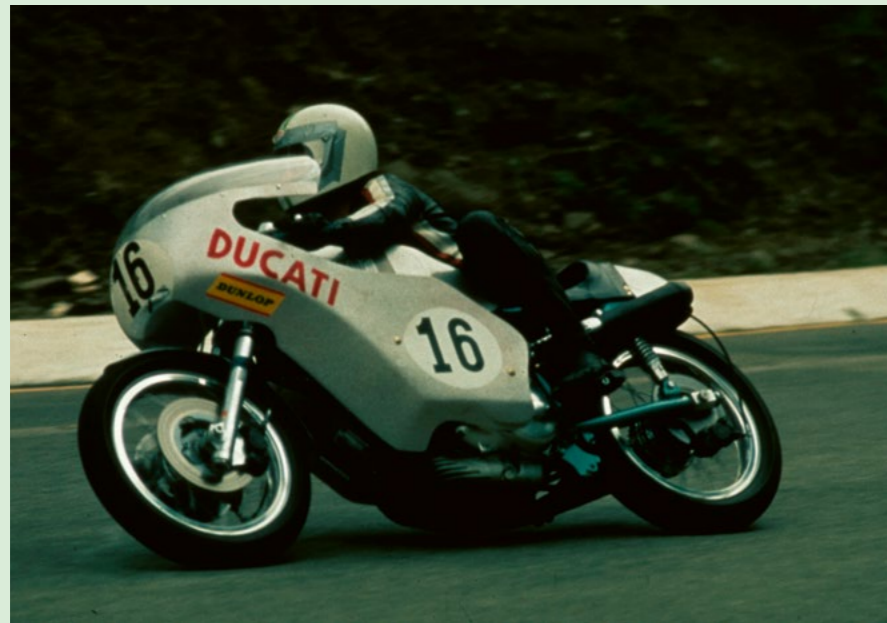

Paul Smart on the 750 GT in the 200 Miglia di Imola.

**A**fter the success of the mono-cylinders, Fabio Taglioni put his great mechanical design prowess to the next test. A wave of Japanese maxi-bikes were becoming the new point of reference for two-wheeled enthusiasts. Just one cylinder, however powerful, was no longer enough, and to compete with these Japanese multi-cylinders, in February 1970 Taglioni began to design a new engine, to be used on both track and road.

And this is how the 500 GP came about, the first Ducati race bike with "L" twin engine marking the first chapter in a long and wonderful story, a cornerstone on which engineering development in Borgo Panigale still rests today. It would be used primarily as a laboratory for the development of future production twins, also trialling solutions such as 4-valve-per-cylinder and desmo timing. It also achieved interesting results on track, despite the

strength of the Agostini-MV pairing. As a result, Taglioni, in agreement with Ducati management, decided to persist with the twin and began working on a 750 road bike.

Hence, the 750 GT was born, the first Ducati 750 cc maxi-bike that, come 1972 and complete with desmodromic system, would compete in the first edition of the highly anticipated 200 Miglia di Imola, known as the "European Daytona".

It proved to be a memorable event. In the three frenetic weeks prior to the race, the regenerated Ducati racing team, headed up by Taglioni's loyal right-hand man, Franco Farné, prepared seven bikes for four riders. These included the indestructible Bruno

## The desmo dream becomes reality.

Spaggiari, always at Taglioni's side, and young English rider Paul Smart, recruited at the last minute. On 23 April, Ducati lined up for a race that was expected to go to Agostini and his 750 cc MV Agusta and yet, against all the odds, it was the Borgo Panigale team that would become the undisputed heroes.

The race was a shoo-in. Spaggiari and Smart stormed the Italian champion, leaving him for dust. The two Ducati riders won the race in front of 85,000 fans and earned their place in the motorcycle history books. This was the first significant success for the twin, equipped for the first time with the desmodromic system.

This victory caused a real boom for Ducati in terms of road bike sales. In 1973, the 750 Super Sport Desmo went into mass production, the first road-going Ducati desmo supersport twin. The company then took a break from racing, putting their faith in two true geniuses of the motorcycle world, Giorgio Nepoti and Rino Caracchi. In 1967, the pair had formed a team, known as NCR (Nepoti, Caracchi Racing), a real dream team

Fabio Taglioni with riders Bruno Spaggiari and Paul Smart.

of mechanics that, as of 1973, would become an external race department for Ducati, representing the company in endurance and speed races.

Based at a workshop just a few miles from the Ducati factory, the NCR team would add to the list of Borgo Panigale achievements with a triple win in the 24 Horas del Montjuic (1973, 1975, 1980) and more success in Italian and European championships for the production-de-



rived bikes. And then the greatest feat of all, the 1978 Tourist Trophy, in which Mike Hailwood, returning after a ten-year absence from racing, triumphed in the Isle of Man Senior TT with the Ducati NCR 900.



Hailwood's win launched Borgo Panigale twins around the world.

# 1977 — 1985

The grand finale:  
from the Pantah  
to the trellis frame.

In his last years at Ducati, Taglioni focused his efforts on transforming the twin. He wanted to make it lighter and more high-performance. The solution he had in mind involved a frame that would weigh less than the classic double cradle used for early twins, both road and race.

And so, in 1978, he designed the Ducati 500 Pantah, a bike that was profoundly different to all his previ-

ous creations. The engine used a toothed rubber belt system that significantly reduced the weight of the unit and made for smoother, more progressive power delivery. The frame was incredibly lightweight, thanks to a trellis structure in moly steel tubing.

Taglioni's creative efforts were not immediately appreciated by the ducatisti. The Pantah 500 was far removed from traditional Ducati styling. But in

1981, when the first production-derived race bike, the Ducati 600 TT2, made its track debut, it was met with unanimous approval. Extremely lightweight and high performance, the 600 TT2 quickly accumulated wins in the TT2 category, including four consecutive world titles with British rider Tony Rutter in the Isle of Man TT.

1984 meant a jump in category and a move to the



A perfect design and new desmodromic timing: the Pantah engine was the forefather to the iconic Ducati twin.



Tony Rutter aboard the 600 TT2.

## The genesis of modern superbikes.

The 750 F1, the star of memorable wins at tracks around the world, was the final, spectacular Fabio Taglioni creation for Ducati.



TT1/F1 championship. The Ducati 600 TT2 evolved into the 750 TT1/F1, a bike that would prove unbeatable from 1984 to 1986, scoring wins at Barcelona, Laguna Seca, Daytona and Misano.

These would be the last Ducati victories to bear the Taglioni name. In 1985, as Ducati was acquired by the Cagiva group, the era of early Ducati twins came to a definitive close. The firm decided to industrialise the new Ducati 851, complete with liquid-cooled, 4-valve Desmoquattro engine, the work of Massimo Bordi and Gianluigi Mengoli, two Taglioni "disciples". The layout of this engine is still used today across an infinite array of Ducati twins.

During his career, which began in 1954 and spanned three decades, Fabio Taglioni collected an impressive array of victories and a great deal of recognition. Originally brought in to help turn the company's fortunes around, on his departure he would leave Ducati with a priceless legacy, a wealth of ideas and projects that contributed to the brand's history and that even now, twenty years after his death in 2001, continue to shape the future.

Mr. Milestone

Foggy came by to pick up his brand new Panigale V4 25° Anniversario 916 and so we took the opportunity to chat to him about the past.

# Mr. Milestone



Carl George Fogarty, known by everyone as Foggy, is one of the most successful World Superbike racers of all time. With Ducati, he won 55 races and 4 World Superbike Championships (1994, 1995, 1998 and 1999).

**Was there ever a moment you realized that you and the 916 were making history?**

At the time, when I was racing on a Ducati 916, I didn't have any idea that history was being made or something special was being created, we just wanted to win races. Maybe it sounds obvious, but it's true. We worked hard race after race, just thinking about what was coming next without considering the bigger picture.

But now, when I look back on it, I see how the two names (Carl Fogarty and Ducati 916) really did become iconic for the sport and important for the racing community worldwide. I'm very, very proud of that. And to be honest I don't think winning races is everything. There has to be some kind of special character and dedication. History can recognize talent, but hard work makes the difference.

bikes as if it were an alien or something completely new. I can even remember journalists wondering whether Ducati had a bigger budget for the design than for the engine. And wondering if it would pay off.

And apparently it did. The 916's forte wasn't just its beauty, because the second moment I will never forget is when I crossed the line at Phillip Island in 1994. Feeling the music of that engine at the end of a race, being on top of the world. It really made my heart explode and I couldn't keep the smile off my face.



**Were there any special moments with the 916 you'd like to mention?**

There are two moments in my relationship with this bike that really make me smile when they come up. The first is when I first saw it at Donington, in the garage. It was truly too beautiful to race with. I was afraid of scratching it or crashing it. And even when you look back at the videos of those years, you can see it stands out from the other

**"Hello baby, I haven't seen you for a long time!"**

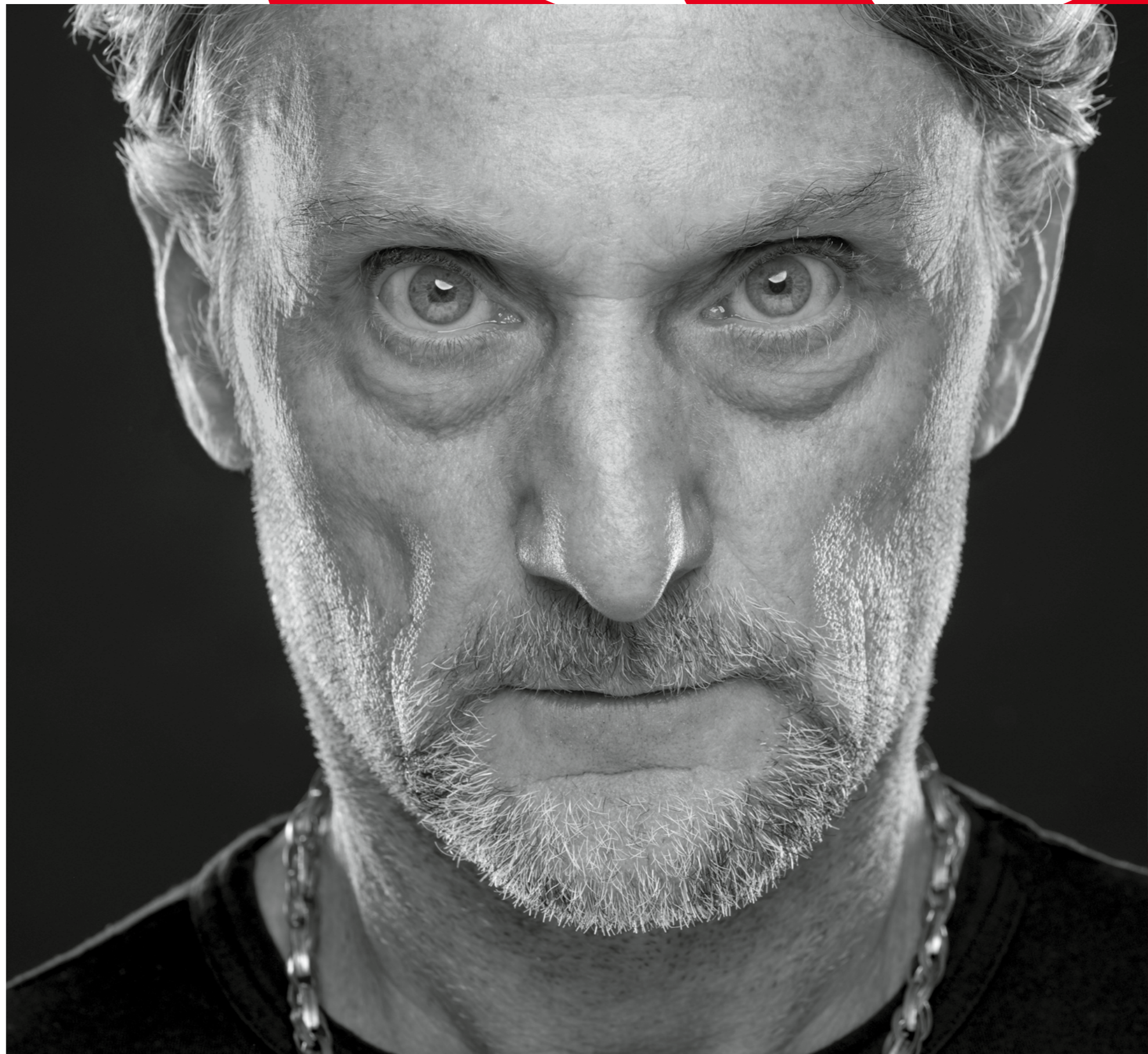

# I really can't wait to get out there and try it myself.

**What did you think when you first saw the new Panigale V5 25th Anniversary 916?**



Well first of all, I can't believe it's been 25 years!

Jokes aside, when I first saw the Panigale V4 25th Anniversary 916 I was blown away. It looks great. It's brand new, but it reminds me of the past with the number 1, the Foggy logo, and the colour of the magnesium wheels is the same as back in the day.

But this bike has a lot of new special parts, from the amazing sound of the V4 to the chassis. I really can't wait to get out there and try it for myself. A great and beautiful bike.



Learn more about the Panigale V4 25° Anniversario 916.

Even though he has spent most of his racing career outside of his home country, first in Spain and then in Moto2 and MotoGP, the UK has always played an important role in the life of Scott Redding.

# BRIT ROCK

The Gloucestershire rider was only 15 on 22 June 2008 when he made history in the 125 class of the British GP as the youngest ever winner in any category. Eleven years on, and the UK was the setting for his first championship title, when he became the 2019 Bennetts British Superbike champion. Redding is now ready to return to the world stage and will compete in the 2020 WorldSBK championship with the Aruba.it Racing – Ducati team and fellow countryman Chaz Davies.

## Hail to the mad king





**Scott, how would you describe this 2019 that saw you return to the UK to race in the BSB championship?**

I'd never raced in the BSB championship and I didn't know 80% of the circuits, so there were a lot of challenges and a lot of pressure, but it was good pressure.

You know, there were a lot of people behind me, the team was good, and the bike worked exceptionally well. All this helped me to clinch the title. Actually, I think this was something I maybe should have done earlier in my career.

It was surprising, in a way. I really enjoyed returning to the UK, feeling the vibe from the fans, racing with no electronics again. After many years in MotoGP, Superbike felt like a return to old-school, hard-core racing and that was something I really enjoyed.

**Ramble on!  
And now's  
the time**

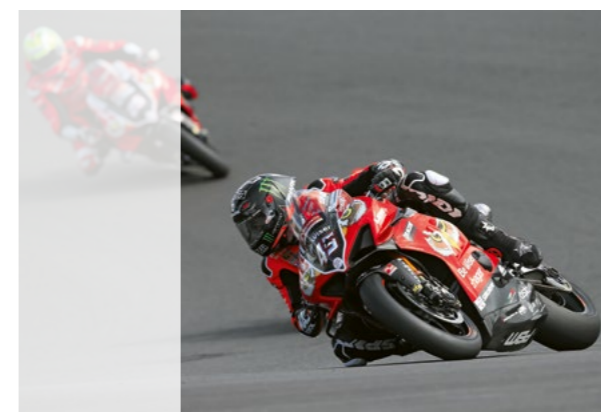

**It's only  
Rock 'n Roll  
but I like it**

**What was your feeling with the BSB Panigale V4 R?**

As soon as I tested the bike, I felt that this was the bike I could win a championship with. That was a good feeling to have. It was perhaps not the easiest bike to ride at BSB tracks, but it had the potential to win and that's all that mattered to me.

**Let's talk about the future. What are your expectations ahead of the coming SBK season with Ducati Corse?**

The goal is to try and win the world title. It's not going to be easy for sure, and we saw many things happening in 2019, but I really believe we have a shot at it, otherwise I wouldn't have accepted Ducati's offer.

I'm 26, I'm still in pretty good shape and in the prime of my career and, with the backing of Ducati and the Aruba team, I don't see why we can't challenge in the first year.

**Do you have a message for your team-mate Chaz Davies?**

I used to race with Chaz in the mini-moto championship when we were younger. We get along really well. It's actually nice going into a team where you know someone, and you know they don't have an ego and are just a generally all-round nice person.

I think this can be a strength, for the team but also for me and Chaz. My message to him is that I wish him all the best for the season to come.

**With Leon Camier on the Barni Racing bike, there will be three British riders on Ducatis next year.**

I think it's good for Ducati, especially in terms of developing the bike. We see that great riders can be competitive with the Panigale and, with Leon too, we'll have much more time. Instead of trying to set up a different bike for each rider, there'll be one package for everybody. If we all work well, I would say that one of us can take the title this year.

**You're going to be supported by hordes of passionate Ducatisti. How do you feel about that?**

It's one of the biggest reasons I go racing to be fair. Racing is entertainment at the end of the day, that's why people come to watch. And I like to entertain on and off the track, that's my strength, part of my personality,

something I know I can do. As for the fans from all over the world who back Ducati, especially in Italy.

I think they're also happy to have someone like me on their side. So I hope we can have a good year, achieve great results and also have a lot of fun away from the track.



**The three 2019 BSB soloists: Scott Redding, Josh Brookes, Tommy Bridewell.**



Learn more about team Aruba.it Racing - Ducati.

# Whole lotta love

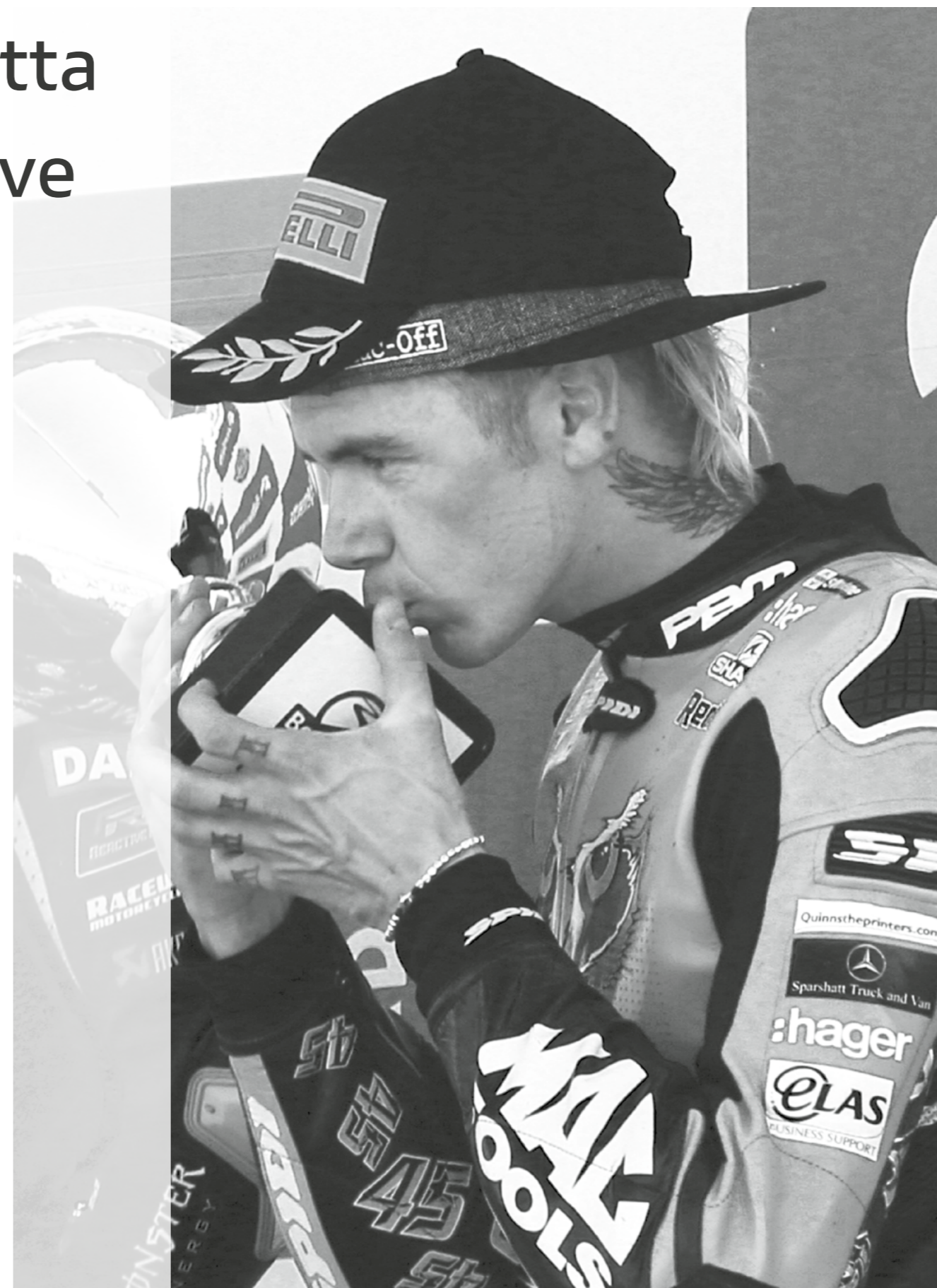



# Pochoer<sup>®</sup>

Model Kits



NEW DIABLO ROSSO™ CORSA II.  
**FOLLOW  
YOUR  
LEANINGS.**

From the world of racing, Pirelli's first multi-compound front tyre for sports and naked bikes is born. Dual Compound front and triple compound rear. Innovative profile. Racing derived tread pattern. Designed for maximum grip and ultimate performance. Diablo Rosso™ Corsa II. Control your Path.  
Ride responsibly.



Dimensions: 518x202x277mm  
Number of parts: 600+  
Scale: 1:4

## 1299 PANIGALE S



**DIABLO  
ROSSO™ CORSA II**



**POWER IS NOTHING WITHOUT CONTROL**



### Ducati Superbike, 1299 Panigale S Anniversario

Presenting the second 1:4 motorcycle kit from Pochoer, and what better choice than the Ducati Superbike, 1299 Panigale S Anniversario. This amazing Ducati 1299 Panigale S Anniversario Pochoer model represents the Ducati super bike of which only 500 were built to celebrate the Italian manufacturer's 90 years of amazing bike making history. These limited edition bikes were further complemented with a striking livery inspired by the MotoGP prototypes and the Superleggera.

The 1:4 Ducati Superbike, 1299 Panigale S Anniversario is made of premium metal die-cast and is supplied ready painted. The kit is easy to build and supplied with detailed instructions. The model consists of more than 600 parts made of an assortment of materials including metal, rubber and premium quality plastic. Wheels, transmission chain, front and rear suspension, brake and clutch levers are all functional and offer an amazing amount of accurate detail.



Ducati Motor Holding S.p.A. official licensed product.



is a trademark and it is the distinctive sign of the tread pattern of Pirelli DIABLO ROSSO™ CORSA II tyres.



# The Year of the Dragon

**The reds of Ducati and the Chinese flag come together in the Ducati China Panigale Cup, the very first official Ducati spec series.**

Borgo Panigale and China, two worlds that have never been so close. Representative of what is a fast-growing passion and an increasingly enthusiastic community, China is now the stage for a brand-new show in Ducati racing history. The Ducati China Panigale Cup marks the first spec series for the red bikes, an ambitious project launched to offer Ducati customers a unique experience, letting them feel like professional racers for a season as they experience the adrenaline typical of unmistakable Ducati DNA.

杜卡迪中国超级杯挑战赛：挑战激情

俯下身，贴近油箱，双手握住车把的瞬间，  
间感受着一车合一的热情，信任与坚持。  
“来吧，我们一同征战，”

松开离合的瞬间，一场场的赛道练习，  
一次次的培训，瞬间闪现在你的眼前

**16 riders, 4 circuits, 8 rounds.  
The 2019 DCPC was non-stop  
excitement, a celebration  
of passion, speed and  
competitive spirit.**

The first edition of the Ducati China Panigale Cup ran from March to October 2019. It began with a special DRE Racetrack session with the full line-up of DRE instructors, including Dario Marchetti, Technical Director of the DRE Racetrack and manager of the Ducati riders' school, and Alessandro Valia, instructor, rider and official Ducati test rider.

The aim was to provide future DCPC riders with track riding secrets and techniques in order to get the best out of the 959 Panigale.

Aboard a special version of this very bike, complete with dedicated livery, Pirelli race tyres and an Akrapovič exhaust, the 16 participants battled it out, the riders in turn equipped with official Ducati race apparel and Suomy helmets.

The four DCPC rounds, organised by Ducati China together with the Ranking Racing Motorsport (Tianjin) Co. Ltd., ran during key Chinese motorsport events, such as the FIA China F4 Championship and the Pan Delta Super Racing Festival, thus guaranteeing participants significant visibility. Competitors enjoyed a real 'day in the life' of a professional racer both on track, thanks to Ducati technical support with a personalised one-to-one service from mechanics and post-race debriefings, and off it, thanks to the excellent hospitality service.

**Mr. Ye Jiayu was crowned  
2019 DCPC Champion,  
followed closely by Ms. Jia  
Tianshuang, the only female  
rider in the series.**



整装待发之时，万众瞩目的目光如炬  
坚定信念就待发车灯亮起

你我亦敌亦友，争锋相对之下是彼此惺惺相惜



**The DCPC is crucial for the development of Chinese motorsport and a once-in-a-lifetime experience for all Ducatisti.**

The first edition successfully completed, work has already begun in preparation for the 2020 Ducati China Panigale Cup, which will see 22 amateur riders take to the track.

Contrary to the 2019 edition, teams are also admitted to this year's competition. Riders can therefore participate individually or as part of a team, receiving the same high-quality package in both cases, or rather, the 959 Panigale in its race configuration, Ducati race apparel, qualified technical support including race prep and technical performance analysis, and hospitality services during the competition, flexible depending on individual preferences.

The Ducati China Panigale Cup represents an important step in terms of motorsport development in China and is a very positive challenge for Ducati. In the words of Ducati China general manager Fabrizio Cazzoli, the success of the 2019 edition came down to "the smiles and sportsmanship that the riders immediately demonstrated. Competitive on track but friends in the garage - this is the true Ducati spirit, instilled in Borgo Panigale and extending as far as the fans in China and all around the world".

**Official information regarding the 2020 Ducati China Panigale Cup is available at [www.ducatchina.cn](http://www.ducatchina.cn)**

其实，每个人都可以成为赛车手  
点燃属于你的赛道时刻



Dominik Paris  
Andrea Dovizioso



# Need for speed

## Life as a racer.

It takes time to reach the front. Both Dominik Paris and Andrea Dovizioso are well aware of this, two athletes who have made a career out of speed and beating the clock. For them, winning comes down to an instant. But that decisive fraction of a second can involve hours, weeks, even months of hard work and intense preparation. Racing against the clock and the continuous search for performance are important to both skiers and motorcyclists. And this means that our two stars, despite being very different people, in fact have very similar lives, as this exclusive double interview reveals.

### What's your relationship with speed?

**Dominik** - I was already really good at skiing as a child and was

always looking for the maximum possible speed. Then as a young athlete I began to measure my skill in speed disciplines. And I realised I was a downhill skier.

**Andrea** - My sport is all about extreme speed, but perhaps the ultimate sensation for me is the relationship I have with the bike. Taking it to the limit, feeling at one with it, it's about more than just simply seeking speed.

### How does it feel to beat the clock?

**D** - You must know how to take on the clock. Winning is a combination of different factors as there's pure speed, yes, but also tactics and trajectories... And when you win, when you have the upper hand, the satisfaction is truly indescribable.

**A** - Doing better than the others is something special. It makes you feel superior, and feeling superior is an extreme feeling, great but at the same time crazy. It motivates you in terms of performance and pushes you to give everything you have.

### Do you ever feel scared?

**D** - No, never scared. But you must always respect the slopes and the other athletes.

**A** - More than I'd like. But that's part of the life of any athlete and, if managed well, fear helps you to avoid mistakes.



# Attention to detail

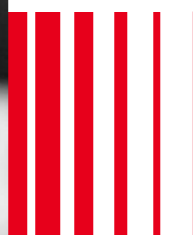

## How careful are you with your materials?

**D** - The materials are fundamental. I look after them together with the professional skiman who follows me and so ably helps me: it's up to me to "ride them", but he is my trusted "mechanic". I am only able to push beyond the limit if I feel confident with the materials.

**A** - Extremely careful, it's an aspect I work hard on, always looking for absolute perfection. In my experience as a rider, I've learned that knowing, understanding and managing all the materials, whether on the bike or in terms of apparel and protectors, really makes the difference.

Andrea Dovizioso, aged 33, has scored more than 1400 points in the MotoGP world championship over seven seasons with Ducati Corse.





# Seeking the limit



## Where do you seek performance away from the track?

**D** - On the stage, with my band. Making music helps me let off steam and enjoy myself. The performance, though different, is important here too. In the end, life is always a question of performance, all around and in everything you do.

**A** - Within myself. I've spent my whole life trying to improve myself, physically and mentally. The race is only the final act, the work beginning at home. And to be ready for it, you must always try to be in the best possible condition.



Dominik Paris, aged 30, has scored 16 wins and a total of 27 podiums in the World Cup and Super G World Cup.



**Talking the colour and design of the bike**

The search for perfection also involves the unique and unmistakable lines and tones of Ducati Style.



# THAT SHADE OF RED



**Andrea Ferraresi**  
Director of the Ducati  
Style Centre

An aeronautical engineer from Modena, Ferraresi has been overseeing the shapes and colours of all Ducati models since 2005.

**What is the power of colour?  
Where does it come from?**

There are few things more appealing than colour. Because colour does not in fact exist, being the result of the visual reworking of the light emitted by an object. And yet, despite originating from subjective perception, colours have universal meanings. And two precise goals – to attract attention and to ensure distinctiveness.

**Is this why the Ducati colour is red?**

In the early years of international motorcycle racing, red was the colour of the Italian teams, but it was only in the '80s that the company decided to adopt it. Although it took a while, the marriage between red and Ducati was an inevitable one, racing being such a fundamental part of the brand's history. Red is now one of the most characteristic elements of Ducati bikes.

**How does Ducati red differ from all other reds?**

It is a passionate, bright, ultra-distinctive red. Ideal for those who want to attract attention. It is also a red that perfectly marries with the "Reduce to the max" rule, as well as the six principles that form the essence of Ducati style, or rather authenticity, simplicity, compactness, distinctiveness, sensuality and sportiness

**How is Ducati red used on each bike so as to guarantee it has its own distinct personality?**

On production bikes, Ducati red is untouchable and cannot undergo any alteration. But we can play with various elements. Not least the components. Certain bikes have less painted parts. The Monster, for example, is red only on the tank, while the Panigale, on the contrary, is entirely painted and has a very extensive surface. The extension of the colour is in itself a form of variation. Also, what distinguishes one red treatment from another are the colour combinations. The effect is of course different if red is paired with black, with grey, or with the specific treatments of materials used for the various components. And then there are the graphics, or rather the slices of colour on the lower fairing, the belly pan, and so on.

Colour is magical.



So subjective,  
yet so universal.

## Colour is tactile.



An emotion to be seen  
and touched.

### **For a bike designer, is colour a starting or a finishing point?**

Both. When you design a bike, even the first drafts are presented in colour. And the colour chosen by the designer is an integral part of the proposal. But it's also a finishing point, because the style development process ends with the so-called Colour & Trim phase, and it is only then that a final decision is made as to the colour of the bike.

### **What tests or controls are carried out on the colour?**

Before assembly, our staff use a spectrophotometer to measure the tone of red of all the painted components, to check if they correspond with the Ducati red reference sample. Once the bike is finished, an overall check is carried out to ensure there is no variation in colour, greater than the permitted tolerance, between the different components.

### **How do alternative colours come about? How far can (or should) they stray from the original?**

As I've said, the designer selects the colour that they believe best

represents the bike already during the sketching phase. This colour may not be red, and was white in the case of the Multistrada 1200 for example. It is often the case that the designer's chosen colour flanks the classic Ducati colour of red with black wheels. An alternative colour that continues to be successful is white with red wheels. And, more recently, we have matte grey with red wheels, the Supersport colour scheme. In any case, the final colours always come down to a combination of designer intuition and market demand.

### **Is there a colour you'd like to see used more on Ducati bikes?**

Yellow, which isn't fashionable right now, but it's an historic Ducati colour. Luckily, the Scrambler family makes good use of it, sating my appetite somewhat, but I'd really like to see its full-blown return to Ducati again. Because if there's one colour our bikes should be aside from red, it's yellow.

## Ducati and Red.



Born to race.  
Made for each other.

The Red Essence is the heart of the new Panigale V2. A muscular but compact bike, with a simple design and bold profiles and a new aesthetic that combines power with the typical elegance of Ducati supersport bikes.

Its first-rate mechanics are jealously guarded by the extensive surfaces of the "double layer" fairing, which gently curve around the refined monocoque frame in its traditional Ducati Red colour.



 Learn more about the new Panigale V2.

## Red like a second skin.



### Ducati Racing: style that intensifies emotion.

Technical apparel for stylish, safe and high-performance track riding.



View the Clothing Collection and shop in the Ducati online store.

### Maximum functionality and freedom of movement.

Ducati racing apparel is designed to ensure maximum levels of practicality and comfort on track. The cutting-edge technical content is guaranteed with the use of refined, lightweight and resistant

materials. Advanced modelling, of everything right down to the protective inserts, accompanies the rider on track, boosting safety and performance.



**Create your customised style with Ducati SuMisura.**

With the Ducati SuMisura configurator, you are guaranteed an even more unique and exclusive look. Connect to the website, select the leathers that best suit your needs, and customise them

as you see fit. Then deliver the draft to your local dealer, who will finalise the order of your 'made to measure' garment.

 **Connect to**  
[www.ducatisumisura.com](http://www.ducatisumisura.com)

As well as leathers, you can also customise your Ducati Corse Carbon 2 helmet with the SuMisura configurator.



MODEL: DA5016 001 © 2019 DUCATI. ALL RIGHTS RESERVED.



Ducati Eyewear

For more information please visit [www.ducati-eyewear.com](http://www.ducati-eyewear.com)

**NEW  
DUCATI  
COLLECTION.  
EXCLUSIVELY  
AVAILABLE AT  
PITTAROSSO.**



Official Partner



Ducati Motor Holding S.p.A official licensed product.

## Massimo Vignelli

# Visually powerful, intellectually elegant.

Massimo Vignelli is considered by many to be the most important graphic designer of the 20<sup>th</sup> century and undoubtedly one of the most significant designers in contemporary history. The creator of the wayfinding system for the New York metro, as well as brand identities including Knoll, Poltrona Frau, American Airlines, Benetton, Bloomingdales, Ford and IBM, Massimo also contributed to a crucial period of Ducati Motor Holding history.

In 1996 something special happened, as Ducati became conscious of itself and its international value. A change in management, the launch of milestone models like the 916 and the Monster, and success in the Superbike championship all led to a new awareness, and new international visibility.

To complete this evolution, a change of pace was needed, also in terms of branding. The need to define and cultivate brand values and

construct a clear brand statement led Ducati to contact Massimo Vignelli, to create what was then known as a "Visual Identification Programme".



# Massimo & Ducati

Becoming recognisable

## Developing visual coherency.



Turning style into a code

The fact that the visual identity product was defined as a “programme” and not a “manual” speaks volumes. This brand definition activity marked a beginning for Ducati, not an end.



There was a real desire to embark on a path of growth and international positioning and, for the first time, the company realised that “The strength of impact of our identity is directly proportional to the coherence of visual communication we will develop.”

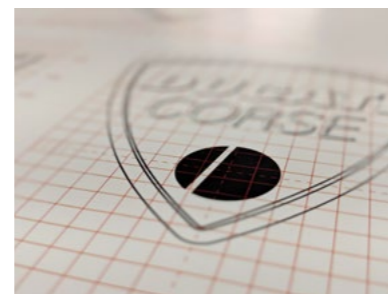

Making a statement

## Global but Italian. Modern but timeless.

A new graphic symbol

This is how the 1996 Ducati brand was born, a comprehensive company image that was both modern and timeless, and firmly rooted in the Italian tradition.

The new logo, developed in collaboration with the Ducati Graphics Office, made its debut on all models built in 1998. The logo, inspired by gems such as the 1970 450 Desmo, recalled the modern characters that had appeared on the 750 Sport, the star of the historic Imola win in 1972. The brand, a meaningful dynamic “D”, was taken directly from the classic Ducati eagle that was found on the much-loved Diana, Daytona and Mach from the Sixties.

Fuel the evolution

Evolution has been ongoing in Ducati. And yet part of the image revolution designed by Massimo still lives on today. In a practical sense, in the logotype, but also in the meticulous attention Ducati pays to its style identity, as if it were its most precious asset.

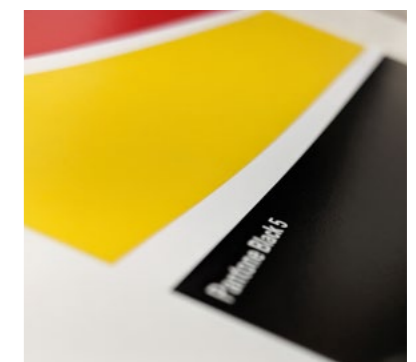

# Massimo & New York City

New York City 1970

If you do it right, it will last forever.

Minimalist and powerful

As of the Sixties, Massimo Vignelli was a key figure behind the modernisation of international graphics, particularly with the spread of the modernist methodology at the hands of Unimark International.

In 1972, two years after having worked on the corporate image of the entire New York transport system together with his colleague and partner Bob Noorda, Vignelli created the famous New York metro map, an abstract diagram of the metro network where each line is identified by a different colour and each stop is represented by a spot.

The map is considered by many to be Vignelli's opus magnum and is part of collections at various museums, including the permanent collection at the Museum of Modern Art (MoMA) in New York.



A pure and simple code.

## A design that never sleeps.

Timeless inspiration

The map is particularly admired by designers, who appreciate the extreme formal purity and clear information, the result of abstract space and the brilliant use of geometry.

But the entire aesthetic of the map still influences the collective imagination today. And it's impossible to cross New York without realising the impact the metro's graphic system has had on the appearance of the entire city. The 1970 map is no longer in use but, like any true design project, Vignelli's signature has left its mark on New York.



Turn the page and continue reading with our trip to NYC aboard the Diavel.





**Her instincts guide her as she heads towards the unknown, the only certainty being that she will find happiness...**

Dawn is breaking. A girl on a motorbike speeds across the Brooklyn Bridge, escaping towards a horizon she still cannot see, but knows exists. This is how I imagine myself, seen from above as I cut loose on my Diavel 1260 S. The metal girders above my head flash past at regular intervals and seem to cage me in. The strong sun shines through the mesh of this imposing structure, turning the tarmac to gold. A golden road that will lead me out. Behind me, the dark steel and glass skyscrapers of Manhattan tower upwards.

I love this city, but I won't let it become my prison. I've ridden its avenues as far as the end of the "island". Along that stretch of road, the sky always seemed too far away and the horizon non-existent.

I tighten my grip on the handlebars of the Diavel and open the throttle for the final act, gritting my teeth and holding my breath as I arrive at DUMBO. From here the view is unique: chaotic Manhattan, seen from the opposite bank of the Hudson River, has never looked more stunning. I just have to linger and look at it, thinking how things change completely when seen from a different point of view.

From the book "The Way Out. New York oltre Manhattan. Fuga in sella a una Ducati" (Skira Editore). Texts by Giulietta Cozzi, photography by Marco Campelli.

 View the digital version on the Ducati website, complete with exclusive images and videos.

# NEW YORK Beyond Manhattan. Riding away on her Diavel 1260 S.



04 vintage

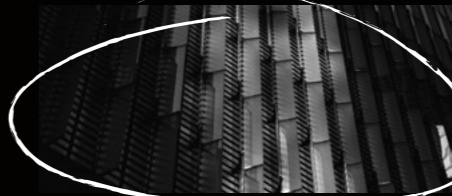

05 modern



06 NYC

07 futurism

08



streets



09 blocks

Redline



10 subways

Magazine



11 movement



12

13

14

suspension



Redline

stillness



15 ladders



16

17

18 bridges



78 90 67

skylines 09 87



05

09

89

78



78

90

67

1260 S 09 87



78 90 67

Madison Ave 09 87

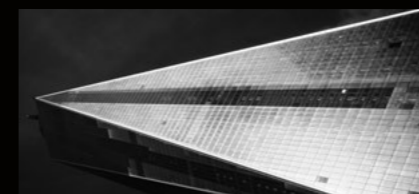

perspective



04 stability

04 wires



04

route

I stop and once again  
 imagine looking at  
 myself from above. Here  
 I am, in a city where  
 dozens of ethnic groups  
 coexist, 170 languages  
 are currently spoken and  
 there are four seasons  
 in a day: "It's New York  
 City, baby".



My Diavel handles like a dream in the chaotic  
 New York traffic. We proceed at a steady pace,  
 negotiating obstacles and unforeseen situa-  
 tions with almost feline grace.  
 A pale colour lit by the sun is now beating down  
 on the tarmac. I'm in Harlem, on the border,  
 and then the skyline vanishes from the rear-  
 view mirrors in a second. I'm surrounded by  
 strong and powerful presences that stand out

against the sky - not the buildings of New York,  
 but majestic, age-old trees.  
 The pace of my ride is faster, while thoughts  
 have slowed. I think about nothing but the ride  
 and enjoy every second of the sheer pleasure of  
 it. In front of me a sea of green grass stretches  
 into infinity.  
 I don't stop, my race continues but has changed:  
 I'm no longer escaping, I can see the horizon.

The constant pleasure of an agile, dynamic and powerful bike.



A companion that never ceases to excite me.



In the last fifteen years a cultural revolution has taken place amidst these blocks, overturning convention and changing all that appeared firmly established and iconic. Just as my revolution started with a race across the bridge, suspended over the Hudson, which leads the way out of Manhattan.

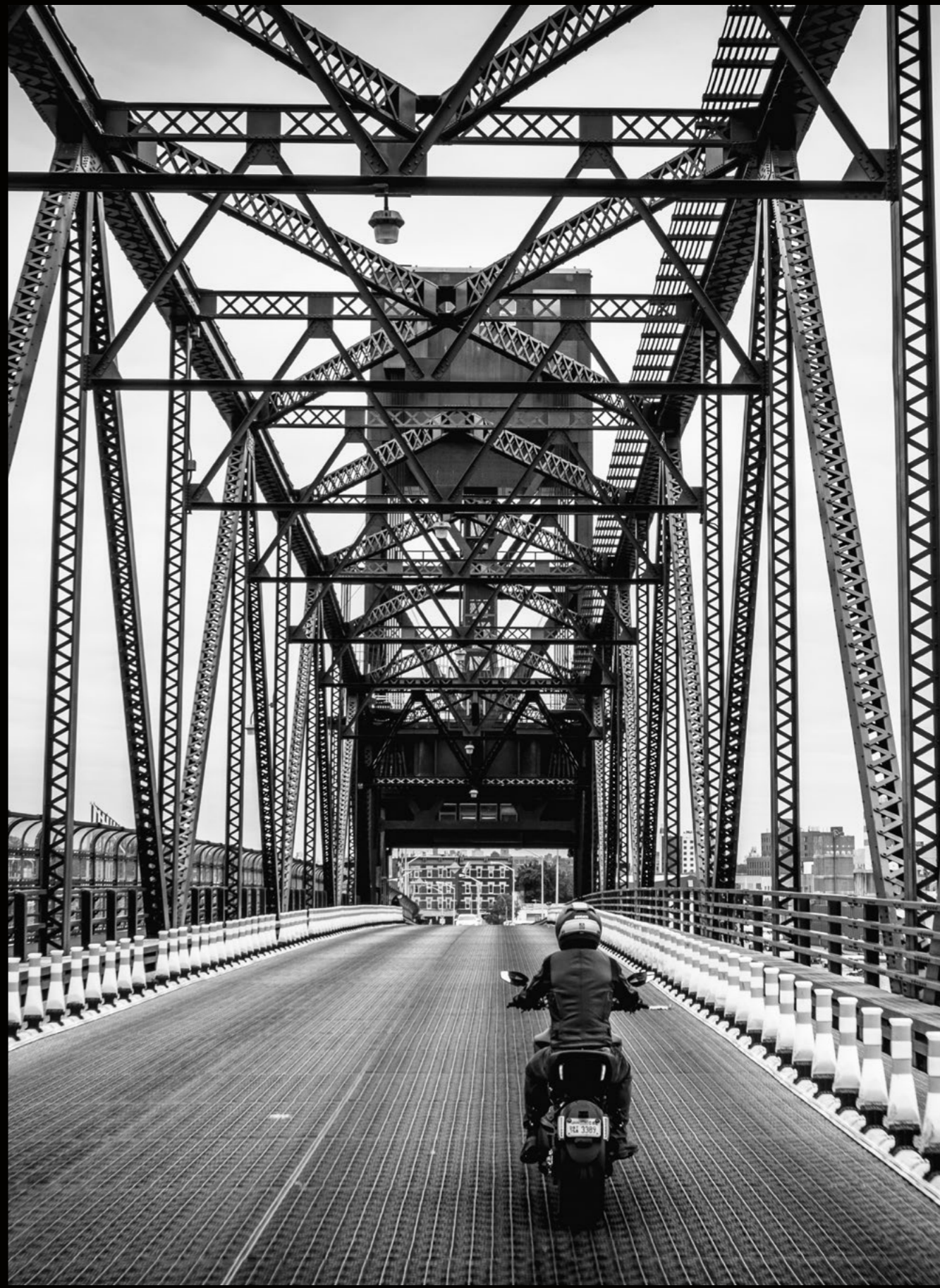



# A 3-star Diavel



The best choose only the best. Chef and owner of Osteria Francescana, the 3-star Michelin restaurant in the heart of Modena, Bottura is a passionate biker who opts for Ducati excellence, or rather the innovative design of the Diavel 1260 S.

**Just as unique and distinct as his culinary creations, Massimo Bottura's Diavel 1260 S is a real work of art.**

## Red, bold and brilliant, and signed by the Chef himself.



A love for his homeland and a passion for bikes and the Made in Italy is all part of Bottura's DNA. This is why he chose Ducati, with which he shares a bold style, meticulous research methods and a creative culture, to design a bike that would mirror his own dynamic character. Together with the Ducati Style Centre, he created a custom version of the new Diavel 1260 S, enhanced with unique and distinctive details such as a black frame, flame red tank with the wording "Lady Day", one of his favourite songs, a seat complete with embroidered signature and a seat tail featuring the Michelin stars.



Learn more about the Diavel 1260 S, now also available as a Ducati Red version with red frame and black wheels.



**BRILLIANCE  
OR MADNESS**

Working as a designer means being able to balance the creative and the rational, instinct and reflectivity. A mental exercise that almost develops into something of a dual personality. Superficially, but constantly.



The creative process involves that fragile balance between rationality and madness. We talk to Jérémie Faraud, Ducati Style Centre designer and creator of the Streetfighter V4, for which his inspiration came from the craziest 'baddy' of all: the Joker.

In the mind of a designer

# Mind shades

**Depending on the dominant side of one's brain, we tend to categorise people as being either creative or rational. But for a designer, creativity and rationality go hand in hand, in equal measure. Does this mean a designer has multiple personalities?**

**Jérémy** - We definitely have multiple professionalisms. Somewhere between engineer and designer. The goal is to implement an aesthetic idea in a way that coheres with social and industrial reality. The designer wears different hats during the creative process. At the start, he is an artist, alone with a pencil and a blank page, with no constraints or technical/technological conditioning. Then, gradually, he thinks more in engineering terms, taking in the reality of the surrounding world, to translate the idea on paper into a feasible project and a usable product.

**Are there ever conflicts, where you come up with something incredibly beautiful but impossible to create for example?**

**Jérémy** - All the time. That's one of the frustrating parts of our work. But it's also very exciting. Because imagining something that has not yet been made means creating new possibilities. And even if something you've just imagined can't be done right now, that doesn't mean that it won't be possible in the future, thanks to new technologies or a different context.

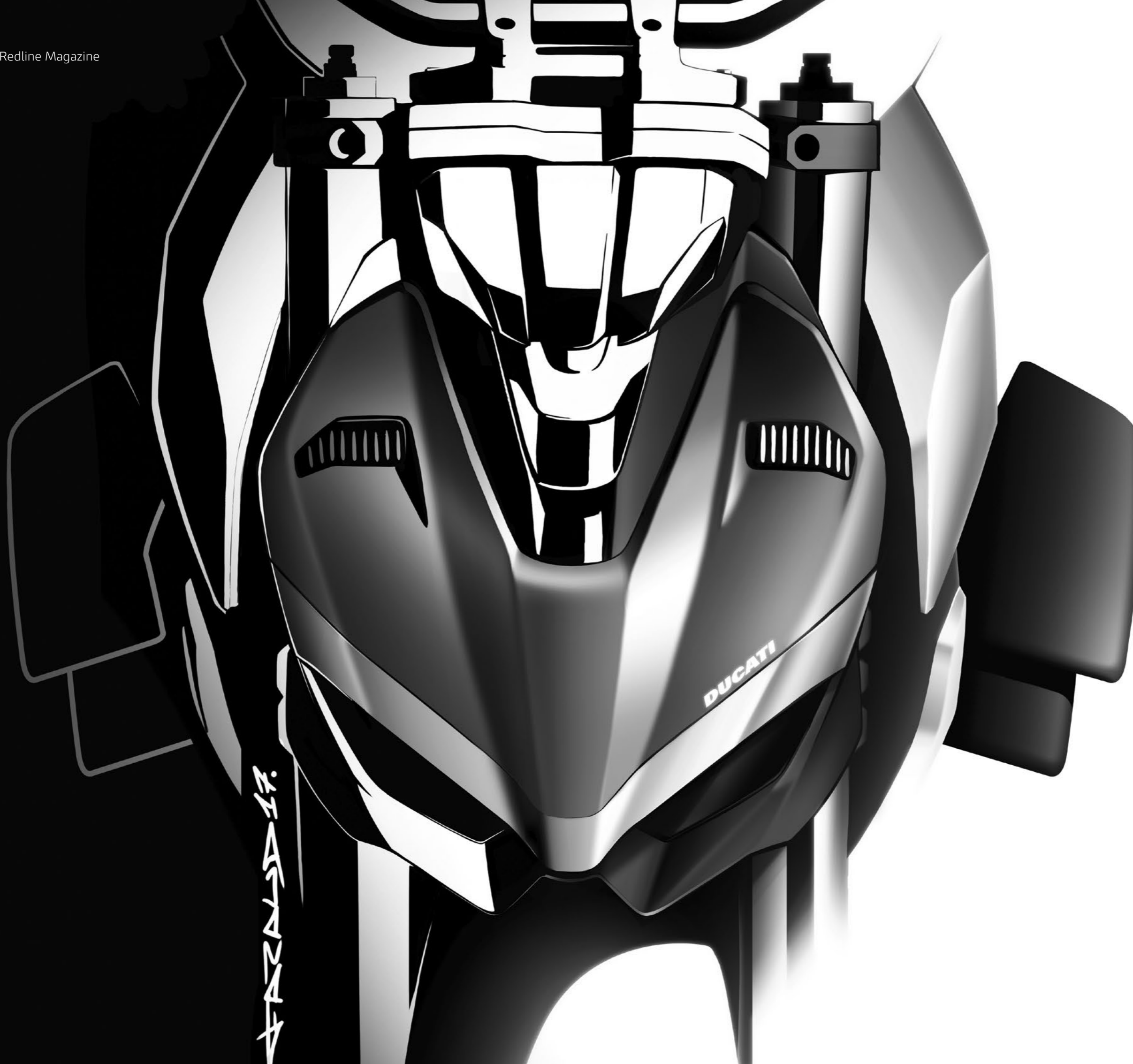

# Ego- mania

A designer must be able to design objects that are totally different to each other. But every designer has his own personality, values, and message to transmit to the world. This common thread, this unique and distinctive spirit, is always evident, across all the projects that bear his signature.

**Jérémy** - I see the bike as a toy. For me, a bike cannot be too serious. It should allow you to have fun. This is what guides my design, as I conceive bikes that have an unrefined appearance, that are not too defined. Sophisticated from a technical standpoint but simple in their concept and overall aesthetic.



**Jérémy** - The Streetfighter V4 is a bike with a dual personality: it's fast on track and dominates on public roads. It was born as a superbike and grew almost like a MotoGP, but is also suitable for urban riding. It's a crazy bike.

Almost insane

Like the Streetfighter V4, the Joker is also two-faced. He's a clown who entertains. But he's also incredibly evil. Three years ago, when Jérémy began designing the bike, the Joker was that of Jared Leto in *Suicide Squad*. A much crazier Joker, a hooligan, terrorising cities in his pink Lamborghini.

Inspired by the Joker, Jérémy combined two very different worlds in the Streetfighter V4, ultimately creating the most powerful Supernaked in the world.



Watch the presentation and learn the secrets behind the design of the Streetfighter V4, unveiled by Jérémy himself.

When I design, I enter another dimension. Time stops and I can do anything I want.





**Mirabilandia**  
PARKS



**YOU WON'T HAVE TO WAIT  
TO GROW UP**

[ducatiworld.mirabilandia.it](http://ducatiworld.mirabilandia.it)



**i-CLIP**  
THE WALLET



CLEAR  
COMPACT  
NOBLE

- | EASY STORAGE FOR UP TO 12 CARDS AND BILLS |
- | VERY COMPACT AND ULTRALIGHT: 18 GRAMS |
- | ECO-RESPONSIBLE GENUINE LEATHER: TANNED CHROME-FREE |
- | MADE IN GERMANY |



[www.i-clip.com](http://www.i-clip.com)

# THE MONSTER IN ME



Jack



Pecco



Michele

## Meet the Monster Squad

We each have our own Monster side. As we take in the brand-new Monster Black on Black, we ask our MotoGP riders about the Monster side to their personality.



# Choose It All

**Ducati Monster is a bike known for its power and agility. What's your favourite side to the Monster?**

**Jack** - The thrill of riding is not just about power. It's about speed. And you get that awesome feeling of speed when the bike is really agile and lightweight. Luckily, with the Monster you get the best of both worlds.

**Pecco** - For me, power is primarily about the response in acceleration, that sensation of being carried away in the low gears, and the Monster is famous the world over for its powerful character.

**Michele** - Definitely the power. The torque you have available at any speed, that lifts you up out of the turns, that's an unmistakable trait. You don't have to open the throttle wide to have fun when you're riding this beauty.

**Everybody has a "Monster" side to their personality. What's yours?**

**Jack** - My racing side. Being able to move fast and reach places quickly. And find solutions before others do.

**Pecco** - My aggression. It comes out when I need it, and I can't contain it.

**Michele** - My determination. I'm a laidback person, but nothing stops me.

# Trying to be the best we can be



### When do you feel at your most "Monster" on your Ducati MotoGP?

**Jack** - When braking. I think I'm one of the stronger guys on the brakes. I really like to find that limit. Just before every turn, I see the sand approaching at very high speed and I love to find the last available inch, exploiting the full power of the bike before diving into the turn.

# Are there moments in the race when it's all about instinct?

**Pecco** - When passing. Battling. Those fractions of a second when anything can happen. You need to have complete confidence in everything around you, the electronics and the dynamics of the bike. But the craziest thing is that you must also have complete confidence in your rivals.

**Michele** - When I win. When we are able to achieve the goals we set ourselves, or even exceed them, it's a priceless feeling.



**Jack** - Sometimes a single decision makes the difference between zero and hero. It is in those situations that every rider knows how to respect and listen to his instincts. To his Monster side.

**Pecco** - If it wasn't for instinct and adrenaline, I wouldn't do this job. But you cannot ignore your rational side altogether, it takes just a moment to go from podium to gravel.

**Michele** - When you don't have time to reflect and just have to act. To make or not make a pass at a delicate moment? That's when instinct makes the difference and real talent shines through.



Discover the Monster 1200, now available with the new Black on Black colour scheme.

# BLACK SOUNDS

Black Music is a symbol of struggle and emancipation, but also soul, spirituality and energy. Born to give voice to our dreams and fears, generally improvised and therefore emotionally authentic, it is still an endless source of musical styles and fusions, something that Ducati Sound curator Alessio Bertalot explains us to at his futuristic home/studio.





# It's in the groove

**What is your connection to Black Music? And how does it represent you?**

I think it can all be attributed to the 'groove'. A very physical sensation, almost ancestral, similar to that combination of vehicle vibration, power and the perception of the engine you feel when you're on a bike. Groove is probably sheer instinct, whether we're talking music or bikes.

**Soul, funk, R'n'B, blues... can you talk us through it all?**

No, I'm actually going to confuse you even further! Jazz, nu jazz, rap, hip hop, reggae, b.a.m., bass, breakbeat, juke, footwork... Black music is a tree with infinite branches. Perhaps the only way to order things is to consider their one shared and incredibly persistent root: Africa.

Black heart



Naked spirit



Black music comes in different times and forms, but as the Chemical Brothers used to say, "It Began in Afrika".

**Is there any particular album that's had a fundamental impact on you?**

Maybe "Funky Drummer" by James Brown. An album that was improvised in the studio like an impromptu journey but that became fundamental in the way it interpreted music. It's all about linearity, regularity and rhythmic power, with changes in bass that accelerate or slow like a bike overtaking and then returning to its cruising speed.



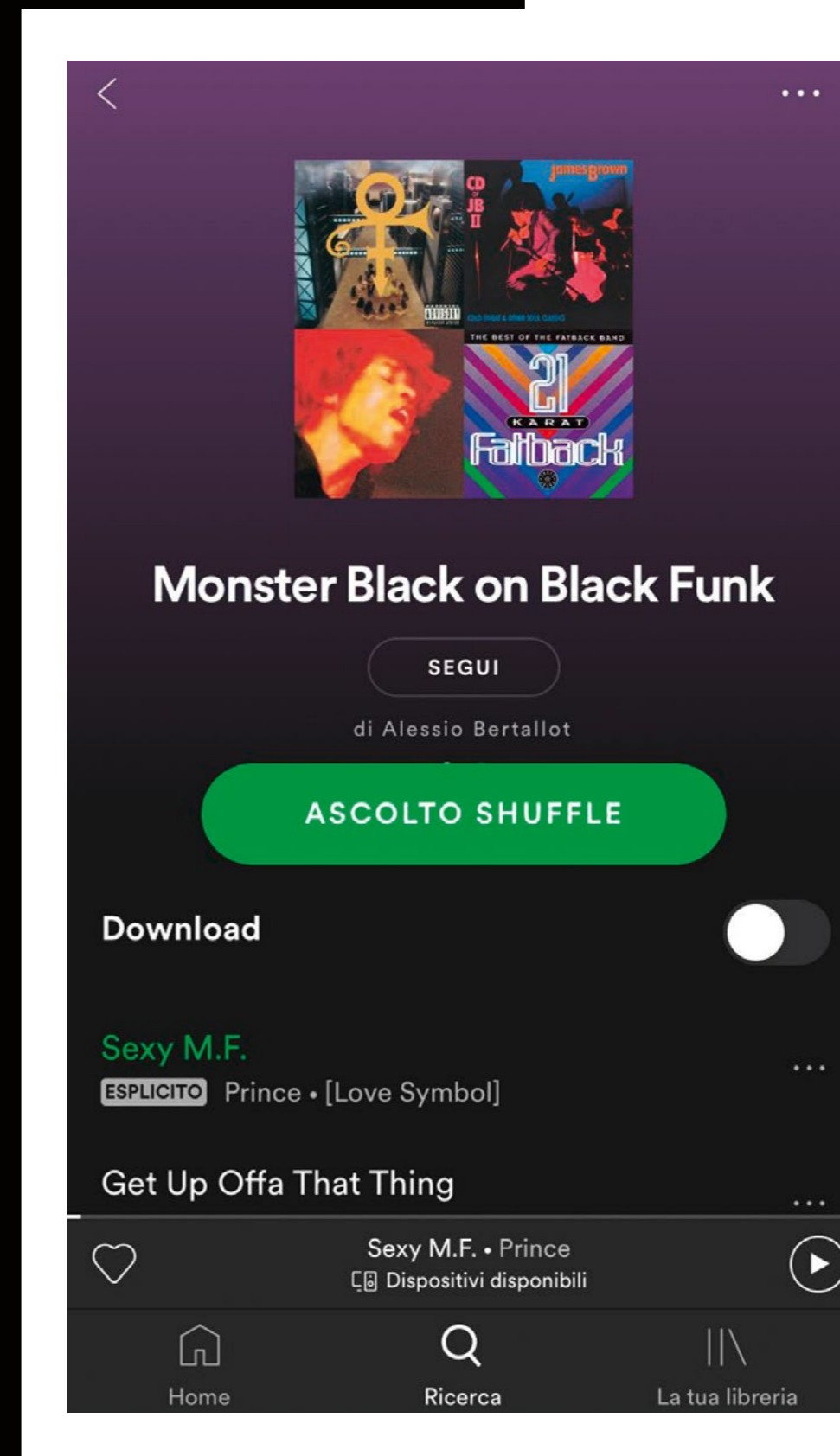

**Who might you consider the ultimate icon of black music?**

Prince. Not only because he sold more than 100 million albums, a crazy number. But because he was able to be both powerful and elegant at the same time. because he revolutionised the world of black music and the music industry as a whole.

**Listen to the best of black music with songs selected by Alessio on the [Ducati Style Spotify channel](#).**

# Scrambler to the Max

**Maxime Richard:  
Canoe sprinter,  
off-road rider,  
Scrambler spirit**

An interview with Maxime Richard, four-time whitewater sprint world champion and proud [Scrambler Desert Sled](#) owner.

**Max, when did you first meet the Ducati Scrambler?**

It was in May 2018 at a Ducati Day in Spa-Francorchamps. I tested the new Scrambler 1100 and I fell in love with it. Not only with the bike, but the whole spirit. When I sit on the bike, or I see the Scrambler clothes, I really feel part of it, it really fits my vision. Now I have a Desert Sled, and I ride it as much as possible.

**So you're more of an off-road type?**

Definitely. Every time I see a narrow road that I'm not sure I can even manage, that's my road. And this is why I love the Desert Sled so much. Because it allows me to try things, with the different suspension, the different tyres. It really fits my way of enjoying riding, which is just... riding!





Immersed in nature, gliding towards freedom.

**What does riding have in common with canoeing?**

Freedom. And the pleasure of gliding. Both canoeing and riding are great ways to travel through nature. In total freedom. When I ride my Desert Sled I can change course, I can change pace. I can get to the river and stop at a beautiful viewpoint. Wildwater canoeing is also like that. I'm giving 100% of course, but I'm in a nice environment, surrounded by beautiful nature.

**Any other hobbies?**

Water is my main thing, but I'm also starting to enjoy being in the air. I skydive and have made around 250 jumps, with a wingsuit as well, and I started base jumping last summer. Canoeing and biking are mostly about nature, skydiving and base jumping are all about adrenaline.

**How would you imagine a Ducati Scrambler canoe?**

Green, in the sense of respecting the environment. Fun, so it would be a river canoe, and customizable, with colours and stuff you can change or add to make it more personal. I always play with colours on my canoe. I want it to express my personality, to be special, to be mine.



# Custom attitude



A chat with Rocco Canosa, Scrambler Product Manager, spokesperson for the Custom Scrambler world and instigator of the Custom Rumble.

**Rocco, tell us about the connection between Ducati Scrambler and the world of Custom bikes?**

Self-expression has always been a big part of Scrambler product strategy and brand communications. Today, our official dealers offer 11 model variants, as well as an accessories catalogue that allows for further customisation of every single bike.



**See all the bike finalists on the Scrambler website.**

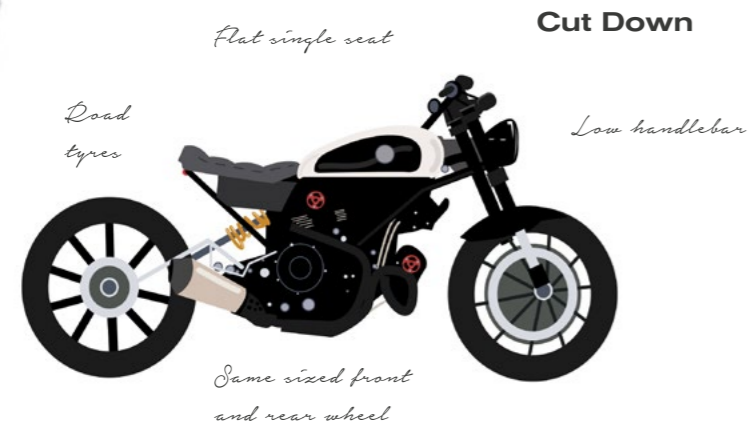

The Custom Rumble is back with five new and exciting challenges!

**From a creative standpoint, to what extent does the Custom world stimulate Scrambler, and vice versa?**

Certain product ideas have come about as a result of seeing how our customers or customisers were personalising their Scrambler. For us, customisation, style and attention to detail are worth a lot more than pure performance. So it was only natural to collate the best interpretations on the market and adopt these in standard production.

**How did the Custom Rumble come about?**

The Custom Rumble is a way of celebrating and exalting self-expression. We've seen continuous evolution since the first edition. It's now open to customers and customisers too. And, along with the participants, the variety of style choices and interpretations has also grown exponentially.

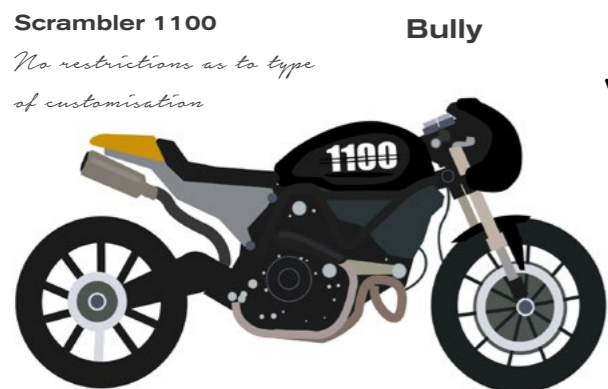

The requirements: a garage, a Scrambler, and endless creativity!

**Beyond the bikes, what is the Custom Rumble?**

The Custom Rumble is not just a contest, but an event that brings people together from all over the world. It's an opportunity for all customisers to discover new trends, offer up their own, and be seen by new fans. Then WDW, where we have the final Custom Rumble prize-giving, is one big party. People who had perhaps only ever interacted on social media are able to meet up, exchange ideas, and share experiences. Custom Rumble is a real community.

**What are the new features of this third edition?**

To really push the creativity of customisers to the max, there are now five challenges, each dedicated to a particular type of bike. Rocker is inspired by the Café Racer culture, the movement that revolutionised the two-wheeled world in the '60s. Cut Down is for those who like things simple, all unnecessary parts are removed and the tail is shortened to create a bobber style bike. All Terrain expresses the wild side of Scrambler. Those taking on this challenge create an enduro style bike, ready to take on any type of terrain. And then there's Outsider, for those who don't want to be limited to one category but want to really unleash their creativity. Lastly, Bully, the challenge dedicated to the "big guns", or rather the Scrambler 1100 family.

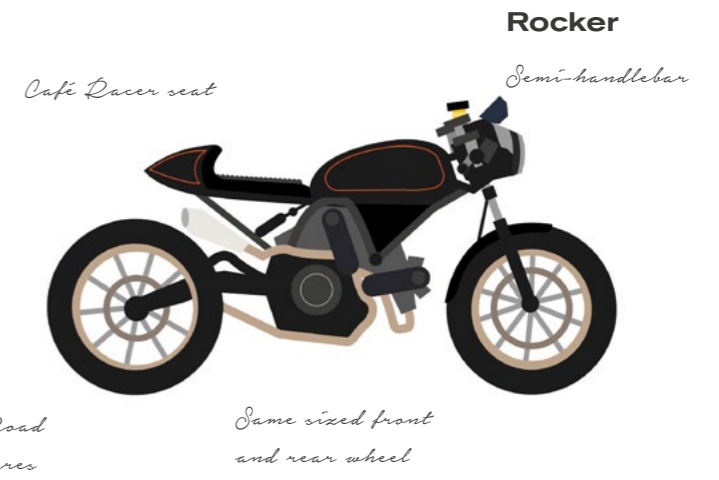

# Paint it black

## Unlimited customisation, endless fun.

Unconventional but fashionable, simple but entertaining. The new Icon Dark presents all the fun and freedom of the Land of Joy in a brand-new guise. Inspired by Scrambler customisers' wildest dreams, this bike is born to accentuate a rider's individual personality and hidden desires.



Learn more about the new Icon Dark.



# Scramblin' ideas!

## Julien and Jérémy: designing Scrambler concepts is twice the fun!



Jérémy Faraud and Julien Clément are the Ducati Scrambler designers. Both French, both the sons of riders, both blessed with extraordinary talent. But they have different tastes when it comes to bikes. Off-road enthusiast Jérémy and the more track-oriented Julien brought the DesertX and Motard concepts to EICMA 2019, two very different ways to experience the Scrambler spirit, conceived almost in their own image.



## Enduro and Motard, the Scrambler way!

**Let's play a game. Julien, what do you like most about the DesertX?**

**Julien** - Definitely the two tanks, front and rear, both divided into two like with the rally bikes, so if one side breaks in a crash, the other is still full and you're not left stranded in the desert. They combine style and functionality. And then the two lights on the top fairing, with technological graphics almost making it look like a smartphone screen.

**And Jérémy, what do you like most about the Motard?**

**Jérémy** - I really like the design of the tank. Designed like that, in brushed aluminium and positioned under the painted cover, it creates a dynamic teardrop look. I also like the number holder on the front light, which takes the shape of the typical Scrambler headlight, one of the distinctive traits of the brand.

**Which Scrambler elements do these two concepts highlight?**

**Julien** - Pure enjoyment.

**Jérémy** - Freedom.

**What is the inspiration behind these bikes?**

**Julien** - I imagined a Scrambler for younger riders. I was inspired by the simplicity and sleekness of early supermotards in the '80s.

**Jérémy** - Those iconic bikes from the golden years of rallying, reinterpreted with a robust design to create a technological vintage bike. Where you can't tell whether it belongs in the future or the past.

**What kind of film could you see them in?**

**Julien** - Any action movie, with lots of sliding, jumping, fleeing and chasing.

**Jérémy** - Mad Max, because it's the perfect bike for the end of the world. You put in all the fuel you can and just go!

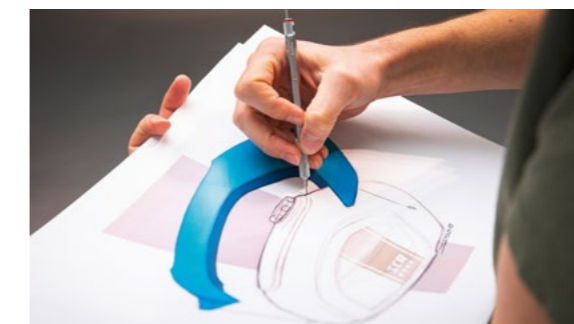

**It sounds like you have a lot of fun designing concepts!**

**Julien** - They are the ultimate expression of our idea. Something else we really like is that feedback from the public is almost instantaneous!

**Jérémy** - Yes, because we are truly free to express our creativity.

# JUST PROs

Two models, all the light heartedness of the full Scrambler experience.

Appealing and contemporary. Enjoyable and comfortable. Equally at ease on city streets and winding country roads, the new Scrambler 1100 PROs see riders travel the Land of Joy with a more conscious, self-confident air.

 Learn more about the new Scrambler 1100 PRO models.



## 1100 PRO

With a 1079 cc engine, generous torque already at low speeds and a 15-litre tank, the Ducati Scrambler 1100 PRO is born to take on even those long-range trips, satisfying a rider's deepest desires.

Practical, powerful and elegant. For enjoyment in and out of town, alone or as a pair.

## 1100 SPORT PRO

A work of art with sports attitude. With its "Matt Black" colour scheme and equipped with Öhlins suspension, a low handlebar and café racer style rear-view mirrors, the 1100 Sport PRO is the beefiest Ducati Scrambler yet.



**Editor in Chief**

Luigi Bianchi

**Design, texts and editorial project**

Craq Design Studio:

Davide Baruzzi

Giulia Tristaino

Pierre Maurice Reverberi

**Editorial Coordination**

Patrizia Cianetti

Isabella Cumani

Sara Alberghini

**Photography**

Archivio Fotografico Ducati, Callo Albanese, Pietro Bianchi, Marco Campelli, Giovanni De Sandre, Milagro, Luca Gambuti, Alex Farinelli, Thomas Maccabelli, Gigi Soldano, Claudio Cipriani, Matteo Cavadini, Diego Indraccolo, Antoine Sedran, Nicola Antonelli, Vignelli Center for Design Studies, Vignelli personal photo collection

Riding a motorcycle is the most exciting way to enjoy the road. The safety of motorcyclists is Ducati's commitment. For more information visit the safety section of the Ducati site ([www.ducati.com](http://www.ducati.com)).

WARNING: The photos and technical information in this catalogue may refer to prototypes subject to modifications during production and are purely for illustration and reference purposes, and are therefore not binding on Ducati Motor Holding S.p.A. Sole Shareholder Company - Company subject to the direction and coordination of AUDI AG ("Ducati"). Ducati cannot be held responsible for any print and/or translation errors.

This catalogue is transnational and therefore some products may not be available and/or their features may vary in accordance with local laws. Not all colours and versions are available in each country. Ducati reserves the right to make changes and improvements to any product without obligation of prior notice or to make such changes to products already sold. Further characteristics of the products are contained in the pertinent owner's manuals.

The products represented are not definitive versions and are therefore subject to significant changes at Ducati's discretion without prior notice. The photographs published in this catalogue show only professional riders under controlled street conditions. Do not attempt to imitate such riding behaviour as it could be dangerous for you or other people on the road. This catalogue, including but not limited to the trademarks, logos, texts, images, graphics and table of contents herein, constitute Ducati intellectual property, or in any event Ducati has the right to reproduce it; any reproduction, modification or other whole or partial use of the catalogue or its contents, including publication on the Internet without the prior written consent of Ducati, is prohibited.

Actual fuel consumption may vary based on many factors, including but not limited to riding style, maintenance performed, weather conditions, surface characteristics, tyre pressure, load, weight of the rider and the passenger, accessories. The weights in running order are considered with all operating fluids, standard equipment and the fuel tank filled to 90% of its useful capacity (UE regulation no. 168/2013). For more information visit [www.ducati.com](http://www.ducati.com).

In memory of Carlin Dunne,  
King of the Mountain.

[www.carlindunne5.com](http://www.carlindunne5.com)





# SCRAMBLER DUCATI



VIA STALINGRADO 27/6  
VIA D'AZEGLIO 34A  
BOLOGNA



DUCATI WORLD, MIRABILANDIA  
RAVENNA

# THE FOOD FACTORY EXPERIENCE

